

MARINE MASTER CLOCK User Manual

Document: 1717en19.doc
Author: PM
Date: 2017-12-22
Page: 1 of 51

User Manual Marine Master Clock



WESTERSTRAND URFABRIK AB

P.O. Box 133
SE-545 23 TÖREBODA

Tel. +46 506 48000
Fax. +46 506 48051

Internet: <http://www.westerstrand.se>
E-mail: info@westerstrand.se

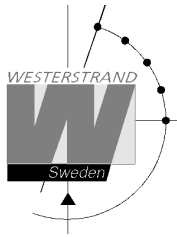

MARINE MASTER CLOCK

User Manual

Document: 1717en19.doc
Author: PM
Date: 2017-12-22
Page: 2 of 51

List of contents

TECHNICAL SPECIFICATIONS	4
GENERAL	4
SLAVE CLOCK OUTPUT.....	4
RELAY OUTPUT	4
ALARM OUTPUT	4
GENERAL DESCRIPTION	5
FRONT PANEL DESCRIPTION	5
KEYBOARD	6
RELAY OUTPUT CONTROL SWITCHES.....	6
STATUS MONITORING LED:S.....	6
OUTPUT LINE MONITORING LED:S	6
INSTALLATION	7
PROGRAMMING	8
GENERAL	8
RUNNING MODE	8
START UP PROCEDURE.....	9
1. Start up questions (this page).....	9
2. Output configuration / Setup (page 10).....	9
3. Enter time of Slave Clocks (page 12).....	9
OUTPUT CONFIGURATION / SETUP	10
SET UTC WHEN IN OPERATION.....	11
SET LOCAL TIME WHEN IN OPERATION	11
SLAVE CLOCK	12
TIME ZONE ADJUSTMENT.....	13
ALARMS	14
Example 1, display alarms	14
Example 1, erase alarms.....	15
Alarm list.....	16
WEEK PROGRAM & DATE PROGRAM	17
Concept description	17
Week Program, example 1 (New program).....	19
Week Program, example 2 (Change program)	20
Week Program, example 3 (Erase program)	21
Week Program, example 4 (Astronomical function).....	22
Week Program, example 5 (Block program).....	23
Week Program, example 6 (Mask program).....	24
Date Program, example (New program).....	25
DISPLAY PROGRAM.....	26
TEMPORARY PROGRAM, EXAMPLE	27
GROUP => PERIOD	28
SPEC.-FUNCTIONS	29
SPEC.-FUNCTIONS	29
Status.....	30
Language	32
Setup.....	33
Software version.....	45

WESTERSTRAND URFABRIK AB

P.O. Box 133
SE-545 23 TÖREBODA

Tel. +46 506 48000
Fax. +46 506 48051

Internet:: <http://www.westerstrand.se>
E-mail: info@westerstrand.se

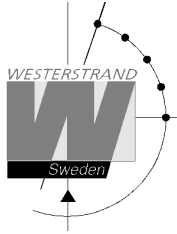

MARINE MASTER CLOCK User Manual

Document: 1717en19.doc
Author: PM
Date: 2017-12-22
Page: 3 of 51

<i>Default LT adjust</i>	<i>46</i>
<i>Display format</i>	<i>47</i>
PROGRAMMING FORM	48
FAULT TRACING	49
ALARM OUTPUT	50

WESTERSTRAND URFABRIK AB

P.O. Box 133
SE-545 23 TÖREBODA

Tel. +46 506 48000
Fax. +46 506 48051

Internet: <http://www.westerstrand.se>
E-mail: info@westerstrand.se

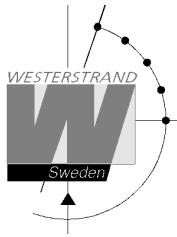

Technical specifications

General

Crystal Frequency:	4,915200 MHz.
Accuracy:	0,1 sec./24 hours (at +20°C).
Microprocessor:	HD6412394.
Connection voltage:	90 - 264V 50 Hz and. 24 V DC -5% +20 %.
Max ripple (24V DC):	0,7V RMS.
Power consumption:	65 W (max)
Ambient temperature:	Between 0° C and +50°C.
Relative humidity:	Max. 85% non-condensing.
IP rating:	IP20
Weight:	5.6 kg.
CE-Approval, EMC:	Emission acc. to EN61000-6-3, Immunity acc. to. EN61000-6-2.

Slave Clock output

Output 1, 2 and 3:

Impulse system:	1/1 minute, 1/2 minute, second, Time Code (TC)
Type of time:	LT, UTC
Impulse length:	Minute 0.1-9.9 sec. Second 0.1-1 sec.

Output 4:

Impulse system:	2-wire: 1/1 minute, 1/2 minute, second, Time Code (TC). 3-wire for Forward/Reverse movement: 1/1-minute alt. 1/2-minut.
Type of time:	LT, UTC
Impulse duration:	Minute 0.1-9.9 sec. Second 0.1-1 sec.
Maximum load / output:	2A (The output is equipped with short circuit protection that resets automatically.)
Total load all outputs:	2.5A

Relay output

Relay outputs:	2 closing potential-free contacts.
Max. load/relay output:	24 V 6A.
Total load relay outputs:	12A
Program memory:	100 years (EEPROM)
Number of control functions:	800.

Alarm output

Number of outputs:	2 Changeover potential-free contacts.
Type of alarms	
Output no. 1 (general alarm):	Overload / short circuit, synchronisation alarm
Output no. 2 (power alarm):	Power failure alarm

WESTERSTRAND URFABRIK AB

P.O. Box 133
SE-545 23 TÖREBODA

Tel. +46 506 48000
Fax. +46 506 48051

Internet: <http://www.westerstrand.se>
E-mail: info@westerstrand.se

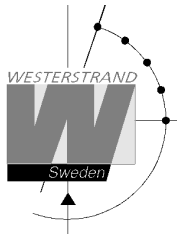

MARINE MASTER CLOCK User Manual

Document: 1717en19.doc
Author: PM
Date: 2017-12-22
Page: 5 of 51

General description

Westerstrand Marine Master Clock is the ideal solution for distribution of both Local and UTC time on board ships.

The Master Clock is equipped with several outputs and inputs for control of Slave Clocks as well as distribution of time to computers and other equipment needing correct time. The four Slave Clock outputs can be individually programmed for different types of clocks. External radio receivers / time synchronisation sources can be connected when higher accuracy is needed.

For control and regulation of various energy consumers such as electrical striking plates, buzzers for pause signalling etc, the master Clock has a built in yearly programmer with two relay outputs.

The Master Clock is equipped with 10 buttons and a 2 x 16 character LCD. To facilitate the change of time zone two of the buttons are dedicated for this purpose. A light dimmer makes it possible to adjust the background illumination to the surrounding light level.

The front mounted power switch is an all pole switch and controls both AC and DC power.

Position IN = Power ON.

Position OUT = Power OFF.

Front panel description

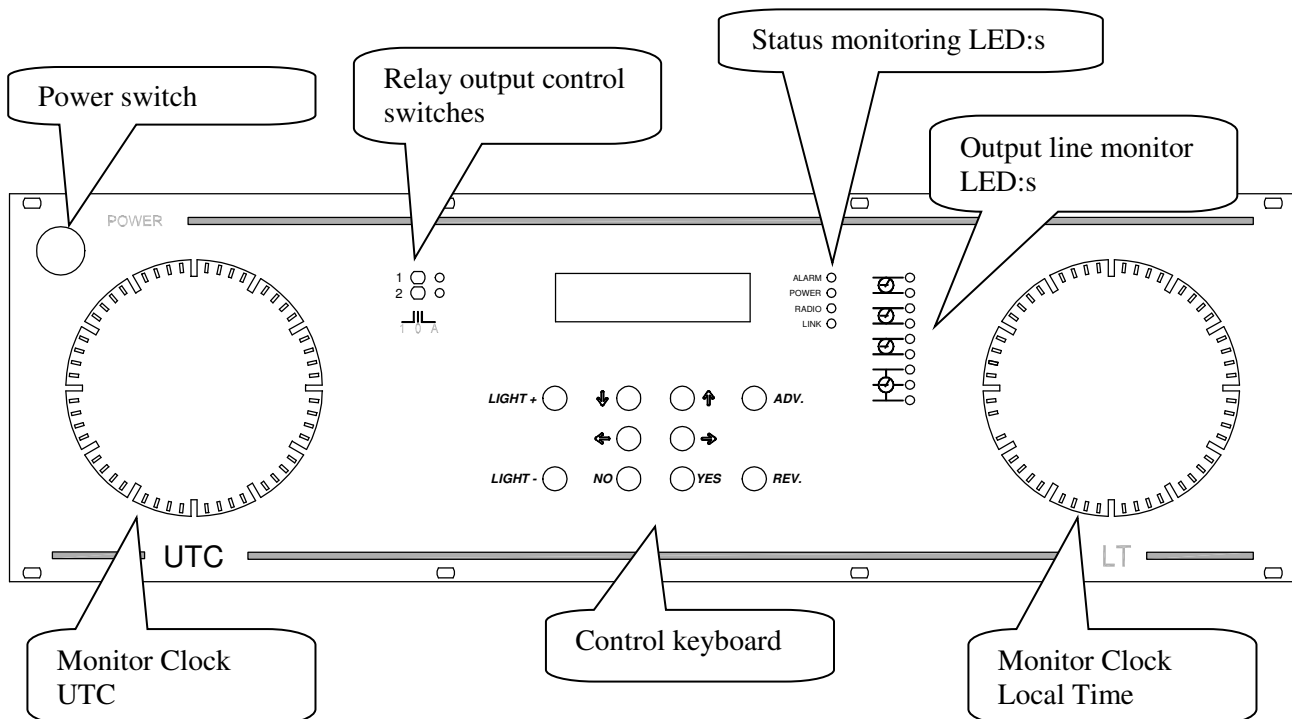

WESTERSTRAND URFABRIK AB

P.O. Box 133
SE-545 23 TÖREBODA

Tel. +46 506 48000
Fax. +46 506 48051

Internet: <http://www.westerstrand.se>
E-mail: info@westerstrand.se

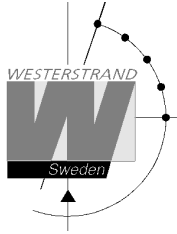

MARINE MASTER CLOCK

User Manual

Document: 1717en19.doc
Author: PM
Date: 2017-12-22
Page: 6 of 51

Keyboard

LIGHT+	Increase LED backlight level
LIGHT-	Decrease LED backlight level
↑↓	Select function / Change and scroll
←	Move left / Cancel / Leave programming mode
→	Move right
NO	Decline
YES	Accept / Enter programming mode
ADV.	Advance Local Time
REV.	Reverse Local Time

Relay output control switches

1	Always ON
0	Always OFF
A	Automatic position, ON/OFF according to program.

Status monitoring LED:s

Alarm	An alarm has occurred, for instance short circuit on one of the output lines.
Power	Power is ON.
Radio	Indicating signal coming from an external radio receiver.
Link	Indicating Ethernet LAN connection. (option)

Output line monitoring LED:s

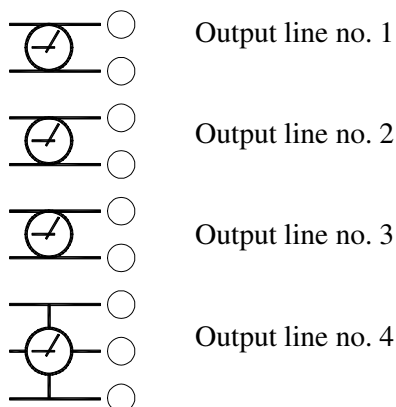

WESTERSTRAND URFABRIK AB

P.O. Box 133
SE-545 23 TÖREBODA

Tel. +46 506 48000
Fax. +46 506 48051

Internet: <http://www.westerstrand.se>
E-mail: info@westerstrand.se

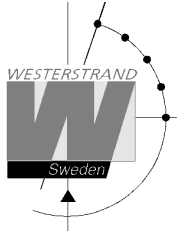

MARINE MASTER CLOCK

User Manual

Document: 1717en19.doc
Author: PM
Date: 2017-12-22
Page: 7 of 51

Installation

The Marine Master Clock is intended for stand, cabinet, wall or desk mounting.

1. Mount the Master Clock.
2. Make sure that all analogue slave clocks shows the same time, for instance 12.00.
4. Before connecting the slave clock lines, check the wires for short circuit, faulty connections etc.
5. Connect the slave clock lines.
6. Connect the signal line/lines (to relay contacts).
7. NOTE! For connection of signals etc., mixed voltages must not be used.
Therefore, choose either 230VAC or, for example 24VAC for connection to the relays.
8. Connect, if included, other accessories/options such as radio synchronisation, RS232 etc.
9. Connect the supply voltage and press the power switch.
10. Proceed to "Start up procedure" page 9.

WESTERSTRAND URFABRIK AB

P.O. Box 133
SE-545 23 TÖREBODA

Tel. +46 506 48000
Fax. +46 506 48051

Internet: <http://www.westerstrand.se>
E-mail: info@westerstrand.se

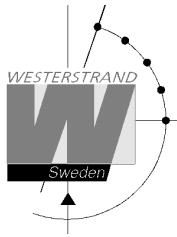

Programming

General

Using 6 buttons and a 2-row 16-character display carries out all programming.
Programming is self-instructive and to simplify the dialogue Yes/No questions are used.

Running mode

When the Time Base module is in operation it shows date and time in the display.
This is called *running mode* in this documentation.

MON 26 SEP 2016
U10:11:35 L12:11

MON 26 SEP 2016
U10:11:35 L12:11

SET UTC

SET LT

SLAVE CLOCK

ALARMS

WEEK PROGRAM

DATE PROGRAM

DISPLAY PROGRAM

TEMPORARY PROGR.

GROUP → PERIODE

SPEC.-FUNCTIONS

- | | |
|------------------------------|-----|
| 1- Select function | ↑↓ |
| 2- Enter programming mode | YES |
| 3- Move sideways | ← → |
| 4- Change/scroll | ↑↓ |
| 5- Accept | YES |
| 6- Cancel / Leave prog. mode | ← |

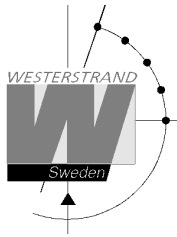

Start up procedure

1. Start up questions (this page)
2. Output configuration / Setup (page 10)
3. Enter time of Slave Clocks (page 12)

STARTING

LANGUAGE
ENGLISH?

When the Master Clock is connected for the first time correct/requested language has to be entered. Press **NO** until requested language occurs in the display e.g. English. Accept with YES.

SET UTC
160926 10:11:00

Set, by using the arrows, the right UTC.
Time format: Year, month, date, hour, minute, second.
Set the time a minute in advance.
Wait for the right time and synchronise using YES.

SET LT
160926 12:11:00

Set, by using the arrows, the right Local Time.
Time format: Year, month, date, hour, minute, second.
Set the time a minute in advance.
Wait for the right time and synchronise using YES.

MON 26 SEP 2016
U10:11:35 L12:11

The Master Clock is now in running mode.

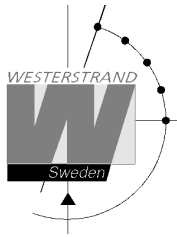

Output configuration / Setup

Each output can be individually configured regarding different parameters. The setup is done from the special function *Setup*. If the default setup is used no configuration is needed.

Default setup:

Slave Clock output no. 1	Impulse system:	1/1 minute
	Type of time: UTC	
	Impulse length:	2 sec.
Slave Clock output no. 2	Impulse system:	-----
	Type of time:	
	Impulse length:	
Slave Clock output no. 3	Impulse system:	-----
	Type of time:	
	Impulse length:	
Slave Clock output no. 4	Impulse system:	3-wire for Forward/Reverse, 1/1-minute.
	Type of time: Local Time	
	Impulse length:	2 sec.

Synchronisation source
NMEA RS485 (NMEA 0183ZDA Time string)

RS232 output
NMSE (NMEA 0183ZDA Time string)

RS485 output
NMSE (NMEA 0183ZDA Time string)

WESTERSTRAND URFABRIK AB

P.O. Box 133
SE-545 23 TÖREBODA

Tel. +46 506 48000
Fax. +46 506 48051

Internet: <http://www.westerstrand.se>
E-mail: info@westerstrand.se

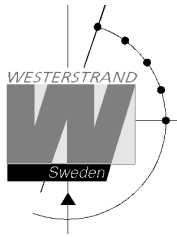

Set UTC when in operation

MON 26 SEP 2016 U10:11:35 L12:11	Select function using ↓.
SET UTC	Enter the programming mode with YES.
SET UTC 1609266 10:11:00	Set, by using the arrows, the right UTC. Time format: Year, month, date, hour, minute, second. Set the time a minute in advance. Wait for the right time and synchronise using YES.
SET UTC	Leave programming mode by pressing ← several times.
MON 26 SEP 2016 U10:11:00 L12:11	The master clock is now back in running mode.

Set Local Time when in operation

Remark: To do normal Time Zone adjustments use the buttons, **ADV** and **REV**.

MON 26 SEP 2016 U10:11:35 L12:11	Select function using ↓.
SET LT	Enter the programming mode with YES.
SET LT 160926 12:11:00	Set, by using the arrows, the right Local Time. Time format: Year, month, date, hour, minute, second. Set the time a minute in advance. Wait for the right time and synchronise using YES.
SET LT	Leave programming mode by pressing ← several times.
MON 26 SEP 2016 U10:11:35 L12:11	The master clock is now back in running mode.

WESTERSTRAND URFABRIK AB

P.O. Box 133
SE-545 23 TÖREBODA

Tel. +46 506 48000
Fax. +46 506 48051

Internet: <http://www.westerstrand.se>
E-mail: info@westerstrand.se

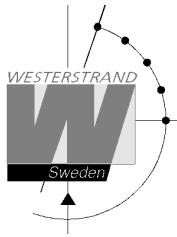

Slave Clock

MON 26 SEP 2016 U10:11:35 L12:11	Select function using ↓.
SLAVE CLOCK	Enter the programming mode with YES.
IMPULSE OUTPUT 1	Select output using ↑↓. Accept with YES.
IMPULSE OUTPUT 1 = 09:07 OFF	IMPULSE OUTPUT 1 = 09.07? (Example) If the slave clocks connected to impulse output 1 shows 09:07 answer YES, if not, set the time shown by the slave clocks.
IMPULSE OUTPUT 1 = 09:07 OFF	Turn ON impulse output 1 by using ↑↓.
IMPULSE OUTPUT 1 = 09:07 ON	Accept with YES
SLAVE CLOCK	Leave programming mode by pressing ← several times.
MON 26 SEP 2016 U10:11:35 L12:11	The master clock is now back in running mode.

NOTE! If a slave clock runs out by a minute, its cabling must be pole changed and the slave clock to be corrected manually.

NOTE! If the time of the slave clocks is ahead of correct/present time the Master Clock will wait until correct time corresponds with the slave clocks.

WESTERSTRAND URFABRIK AB

P.O. Box 133
SE-545 23 TÖREBODA

Tel. +46 506 48000
Fax. +46 506 48051

Internet: <http://www.westerstrand.se>
E-mail: info@westerstrand.se

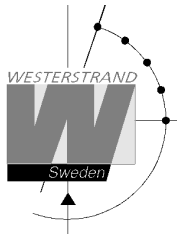

Time zone adjustment

To change Local Time zone two buttons are used. The buttons are named ADV and REV.
To advance the Local Time slave clocks to a new time zone press button ADV.

Example:

MON 26 SEP 2016
U10:11:35 L12:11

Press button ADV.

LOCAL TIME ADJ.
60m ?

Use the default value or change by pressing ADV.
Accept with YES.

LOCAL TIME ADJ. !

The Local Time slave clocks will now advance 60 minutes.

MON 26 SEP 2016
U10:11:35 L13:11

When the correction is finished the display is automatically returned to running mode.

To reverse the Local Time slave clocks to a new time zone press button REV.

Example:

MON 26 SEP 2016
U10:11:35 L12:11

Press button REV.

LOCAL TIME ADJ.
- 60m ?

Use the default value or change by pressing REV.
Accept with YES.

LOCAL TIME ADJ. !

The Local Time slave clocks will now be adjusted as below:
1 Min forward clock's stop 60 min
0,5 Min F/B clock's: Reverse 60 Min
TC Clock's: 11 hours forward

MON 26 SEP 2016
U10:11:35 L11:11

When the correction is finished the display is automatically returned to running mode.

Remark: To interrupt a time zone adjustment in progress press button ← and YES.

WESTERSTRAND URFABRIK AB

P.O. Box 133
SE-545 23 TÖREBODA

Tel. +46 506 48000
Fax. +46 506 48051

Internet: <http://www.westerstrand.se>
E-mail: info@westerstrand.se

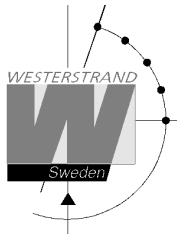

Alarms

This function is used to display and erase the different alarms in the master clock.

ALARMS- DISPLAY

To show the alarms

ALARMS- ERASE

To erase the alarms

Example 1, display alarms

MON 26 SEP 2016
U10:11:35 L12:11

Select function using $\uparrow\downarrow$.

ALARMS

Accept with YES.

ALARMS- DISPLAY

Press NO until the wished function is shown.
Accept with YES.

09AUG 15:52
NO RADIO 30

The alarm is displayed.
Press $\uparrow\downarrow$ to see next alarm.
Return to running mode press \leftarrow .

ALARMS- DISPLAY

\leftarrow .

ALARMS

\leftarrow .

MON 26 SEP 2016
U10:11:35 L12:11

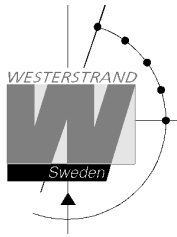

MARINE MASTER CLOCK User Manual

Document: 1717en19.doc
Author: PM
Date: 2017-12-22
Page: 15 of 51

Example 1, erase alarms

MON 26 SEP 2016 U10:11:35 L12:11	Select function using ↑↓ .
ALARMS	Accept with YES.
ALARMS- ERASE	Press NO until the wished function is shown. Accept with YES.
09 AUG 15:52 NO RADIO	The alarm is displayed. Press YES to erase the alarm.
ERASE?	Accept with YES.
ALARMS- ERASE	Return to running mode press ←.
ALARMS	←.
MON 26 SEP 2016 U10:11:35 L12:11	

WESTERSTRAND URFABRIK AB

P.O. Box 133
SE-545 23 TÖREBODA

Tel. +46 506 48000
Fax. +46 506 48051

Internet: <http://www.westerstrand.se>
E-mail: info@westerstrand.se

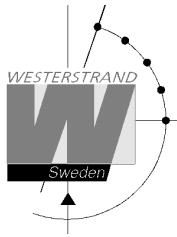

MARINE MASTER CLOCK

User Manual

Document: 1717en19.doc
 Author: PM
 Date: 2017-12-22
 Page: 16 of 51

Alarm list

The following alarms are available

Type of alarm	Alarm code	Indication	Reason for alarm	Action
NO RADIO	30	Red alarm LED lit. General alarm relay activated.	The Master Clock has not been synchronised within the alarm limit.	Check the external synchronisation source. If no external source is used inactivate the alarm. See special function/ setup sync. source page 36.
UF LOW	52	Red alarm LED lit. General alarm relay activated.	Impulse voltage below alarm limit.	Remove connected clocks and clear the alarm. If OK, check clocks and wiring.
SHORT CIRCUIT	53	Red alarm LED lit. Common alarm relay activated.	Short circuit on impulse amplifier.	Remove short circuit. If OK, clear the alarm.
CURRENT LOW	61	Red alarm LED lit. General alarm relay activated.	Impulse current on output no. 1 is below alarm limit.	Check output connections. If OK, clear the alarm.
CURRENT LOW	62	Red alarm LED lit. General alarm relay activated.	Impulse current on output no. 2 is below alarm limit.	Check output connections. If OK, clear the alarm.
CURRENT LOW	63	Red alarm LED lit. General alarm relay activated.	Impulse current on output no. 3 is below alarm limit.	Check output connections. If OK, clear the alarm.
CURRENT LOW	64	Red alarm LED lit. General alarm relay activated.	Impulse current on output no. 4 is below alarm limit.	Check output connections. If OK, clear the alarm.
CURRENT HIGH	71	Red alarm LED lit. General alarm relay activated.	Impulse current on output no. 1 is above alarm limit.	Check output load. If OK, clear the alarm.
CURRENT HIGH	72	Red alarm LED lit. General alarm relay activated.	Impulse current on output no. 2 is above alarm limit.	Check output load. If OK, clear the alarm.
CURRENT HIGH	73	Red alarm LED lit. General alarm relay activated.	Impulse current on output no. 3 is above alarm limit.	Check output load. If OK, clear the alarm.
CURRENT HIGH	74	Red alarm LED lit. General alarm relay activated.	Impulse current on output no. 4 is above alarm limit.	Check output load. If OK, clear the alarm.
CURRENT HIGH	75	Red alarm LED lit. General alarm relay activated. (Remark: Alarm 75 is only used in a 3-wire Forward/Reverse system.)	Impulse current on output no. 4 is above alarm limit.	Check output load. If OK, clear the alarm.

WESTERSTRAND URFABRIK AB

P.O. Box 133
 SE-545 23 TÖREBODA

Tel. +46 506 48000
 Fax. +46 506 48051

Internet: <http://www.westerstrand.se>
 E-mail: info@westerstrand.se

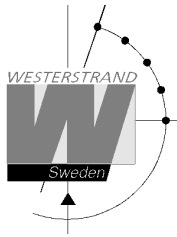

Week Program & Date Program

Using these two functions, programming of the outputs is made.

Concept description

- Program** A "program" refers to programming an output to a certain time. The word program represents a single time event and several programs are defined as a *group* of programs.
For example: output 2 switches on every working day (Monday-Friday) at 8.00.
- Week program** A week program is a program, which is repeated every week. You can for each program choose for which days of the week it shall be valid:
Individual or block programming.
M = Monday
T = Tuesday
W = Wednesday
T = Thursday
F = Friday
S = Saturday
S = Sunday
- Date program** A date program is a program, which is valid for a specific date.
- Group** A group of programs, signal events.
- Type of signals** There are some different kinds of signals, depending on how the relay output is to be used.
- ON/OFF** Is used when a longer lasting switching ON is required, e.g. for controlling fans, door locks, lighting etc.
- 01s** Is used when a short pulse is required, e.g. for bells/buzzers.
Pulse duration selectable from 1-99 seconds.
- Astr.** Astr. (Twilight) is a function which closes/opens a predestined relay at sunrise resp. sunset. Which day and month of the year it is, and where the Time Central programmer is located geographically, define the time of the sunrise resp. sunset. The sunrise resp. sunset are calculated in the software of the Y8 module. The geographic position of the Time Central is entered at starting up. A map indicating latitude (°north) and longitude (°east) is enclosed.
- Mask** A program that is repeated f. ex every hour is easily entered by the use of mask program.
XX.15.00 ; the program is repeated every hour att minute 15.
08.XX.00 ; the program is repeated every minute between 08.00 and 09.00.
XX.XX.00 ; The program is repeated every minute.

WESTERSTRAND URFABRIK AB

P.O. Box 133
SE-545 23 TÖREBODA

Tel. +46 506 48000
Fax. +46 506 48051

Internet:: <http://www.westerstrand.se>
E-mail: info@westerstrand.se

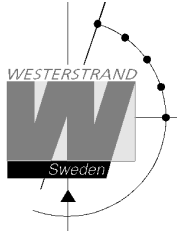

MARINE MASTER CLOCK

User Manual

Document: 1717en19.doc
Author: PM
Date: 2017-12-22
Page: 18 of 51

To simplify programming 3 sub menus are used:

WEEK PROGRAM
NEW GROUP A

To enter new programs.

WEEK PROGRAM
ERASE GROUP A

To erase a separate existing program.

WEEK PROGRAM
CHANGE GROUP A

To change existing programs.

WESTERSTRAND URFABRIK AB

P.O. Box 133
SE-545 23 TÖREBODA

Tel. +46 506 48000
Fax. +46 506 48051

Internet: <http://www.westerstrand.se>
E-mail: info@westerstrand.se

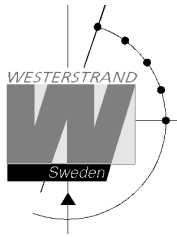

MARINE MASTER CLOCK

User Manual

Document: 1717en19.doc
Author: PM
Date: 2017-12-22
Page: 19 of 51

Week Program, example 1 (New program)

Example: Outputs No. 2 shall switch on Monday – Friday at 09.00 and off at 17.00.

```
MON 26 SEP 2016
U10:11:00 L12:11
```

Select function using $\uparrow\downarrow$.

```
WEEK PROGRAM
```

Enter programming mode using YES.

```
WEEK PROGRAM
NEW          GROUP A
```

Select new program using YES.

```
WEEK PROGRAM
NEW          GROUP A
```

Select group of programs using $\uparrow\downarrow$, accept using YES.

```
OUTPUT 2      ON
----- 08:00:00
```

Select output using $\uparrow\downarrow$. Move to the right using \rightarrow .

```
OUTPUT 2      ON
----- 08:00:00
```

State type of signal using $\uparrow\downarrow$.

```
OUTPUT 2      ON
MTWTF-- 08:00:00
```

State the days the program shall function using $\uparrow\downarrow$.
Move to the right using \rightarrow .

```
OUTPUT 2      ON
MTWTF-- 09:00:00
```

State the time of the program using $\uparrow\downarrow$.

Move to the right using \rightarrow .

Accept using YES.

If the program is approved the text "Program saved" is displayed quickly.

```
OUTPUT 2      OFF
MTWTF-- 17:00:00
```

Continue with programming OFF for the same output or leave programming by pressing \leftarrow several times.

```
WEEK PROGRAM
```

```
MON 26 SEP 2016
U10:11:00 L12:11
```

WESTERSTRAND URFABRIK AB

P.O. Box 133
SE-545 23 TÖREBODA

Tel. +46 506 48000
Fax. +46 506 48051

Internet: <http://www.westerstrand.se>
E-mail: info@westerstrand.se

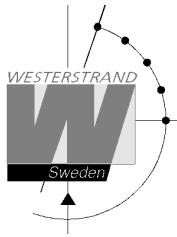

Week Program, example 2 (Change program)

Example: A signal on output 1, Monday – Friday at 08.00, shall be changed to 08.15. Signal length is 5 seconds.

MON 26 SEP 2016
U10:11:00 L12:11

Select function using $\uparrow\downarrow$.

WEEK PROGRAM

Enter programming mode using YES.

WEEK PROGRAM
CHANGE GROUP A

Select change program using YES.

WEEK PROGRAM
CHANGE **GROUP A**

Select group of programs using $\uparrow\downarrow$, accept using YES.

OUTPUT 2 05S
MTWTF-- 08:00:00

Select output using $\uparrow\downarrow$. Move to the right using \rightarrow .

OUTPUT 2 05S
MTWTF-- 08:00:00

Step forward to the program, which is to be changed using NO and YES.

OUTPUT 2 05S
MTWTF-- 08:**15**:00

Change the time to 09.15 using the arrows.
Accept using YES.

WEEK PROGRAM

Leave the programming by pressing \leftarrow several times.

MON 26 SEP 2016
U10:11:00 L12:11

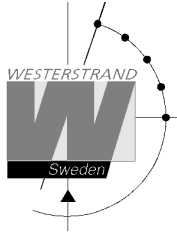

MARINE MASTER CLOCK

User Manual

Document: 1717en19.doc
Author: PM
Date: 2017-12-22
Page: 21 of 51

Week Program, example 3 (Erase program)

Example: A signal on output 1, Fridays at 16.30 shall be deleted. Signal length is 5 seconds.

```
MON 26 SEP 2016  
U10:11:00 L12:11
```

Select function using $\uparrow\downarrow$.

```
WEEK PROGRAM
```

Enter programming mode using YES.

```
WEEK PROGRAM  
ERASE GROUP A
```

Select erase program using YES.

```
WEEK PROGRAM  
ERASE GROUP A
```

Select group of programs using $\uparrow\downarrow$, accept using YES.

```
OUTPUT 1 ON  
MTWTF-- 09:00:00
```

Select output using $\uparrow\downarrow$. Move to the right using \rightarrow .

```
OUTPUT 1 05S  
----F-- 16:30:00
```

Step forward to the program that is to be erased using NO and YES.
Accept using YES.

```
WEEK PROGRAM
```

Leave the programming by pressing \leftarrow several times.

```
MON 26 SEP 2016  
U10:11:00 L12:11
```

WESTERSTRAND URFABRIK AB

P.O. Box 133
SE-545 23 TÖREBODA

Tel. +46 506 48000
Fax. +46 506 48051

Internet: <http://www.westerstrand.se>
E-mail: info@westerstrand.se

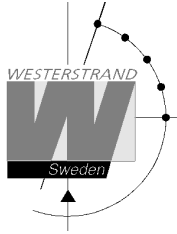

Week Program, example 4 (Astronomical function)

Example: Output No. 1 shall switch ON all sunset All days and switch OFF at sunrise.

MON 26 SEP 2016
U10:11:00 L12:11

Select function using $\uparrow\downarrow$.

WEEK PROGRAM

Enter programming mode using YES.

WEEK PROGRAM
NEW GROUP A

Select new program using YES.

WEEK PROGRAM
NEW **GROUP A**

Select group of programs using $\uparrow\downarrow$, accept using YES.

OUTPUT 2 ON
MTWTF-- 08:00:00

Select output using $\uparrow\downarrow$. Move to the right using \rightarrow .

OUTPUT 2 **ASTR**
MTWTF--

State type of signal using $\uparrow\downarrow$.

OUTPUT 2 ASTR
MTWTF--

State the days the program shall function using $\uparrow\downarrow$.
Accept using YES.

If the program is approved the text "Program saved" is displayed quickly.

WEEK PROGRAM

Leave the programming by pressing \leftarrow several times.

MON 26 SEP 2016
U10:11:00 L12:11

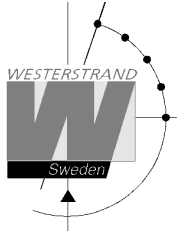

Week Program, example 5 (Block program)

Example: Outputs No. 2 shall switch on Monday, Wednesday and Friday at 09.00.

MON 26 SEP 2016 U10:11:00 L12:11	Select function using $\uparrow\downarrow$.
WEEK PROGRAM	Enter programming mode using YES.
WEEK PROGRAM NEW GROUP A	Select new program using YES.
WEEK PROGRAM NEW GROUP A	Select group of programs using $\uparrow\downarrow$, accept using YES.
OUTPUT 2 ON ----- 08:00:00	Select output using $\uparrow\downarrow$. Move to the right using \rightarrow .
OUTPUT 2 ON ----- 08:00:00	State type of signal using $\uparrow\downarrow$.
OUTPUT 2 ON M-W-F-- 08:00:00	State the days the program shall function using $\uparrow\downarrow$. Move to the right using \rightarrow .
OUTPUT 2 ON M-W-F-- 09:00:00	State the time of the program using $\uparrow\downarrow$. Move to the right using \rightarrow . Accept using YES. If the program is approved the text "Program saved" is displayed quickly.
OUTPUT 2 OFF M-W-F-- 09:00:00	Continue with programming OFF for the same output or leave programming by pressing \leftarrow several times
WEEK PROGRAM	
MON 26 SEP 2016 U10:11:00 L12:11	

WESTERSTRAND URFABRIK AB

P.O. Box 133
SE-545 23 TÖREBODA

Tel. +46 506 48000
Fax. +46 506 48051

Internet: <http://www.westerstrand.se>
E-mail: info@westerstrand.se

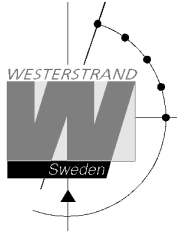

MARINE MASTER CLOCK

User Manual

Document: 1717en19.doc
Author: PM
Date: 2017-12-22
Page: 24 of 51

Week Program, example 6 (Mask program)

Example: Outputs No. 2 shall switch on for 5 seconds every hour at minute 15, all days in the week.

```
MON 26 SEP 2016
U10:11:00 L12:11
```

Select function using $\uparrow\downarrow$.

```
WEEK PROGRAM
```

Enter programming mode using YES.

```
WEEK PROGRAM
NEW          GROUP A
```

Select new program using YES.

```
WEEK PROGRAM
NEW          GROUP A
```

Select group of programs using $\uparrow\downarrow$, accept using YES.

```
OUTPUT 2 ON
----- 08:00:00
```

Select output using $\uparrow\downarrow$. Move to the right using \rightarrow .

```
OUTPUT 2 05S
----- 08:00:00
```

State type of signal using $\uparrow\downarrow$.
05S = Pulse with 5 seconds length.

```
OUTPUT 2 05S
MTWTFSS 08:00:00
```

State the days the program shall function using $\uparrow\downarrow$.
Move to the right using \rightarrow .

```
OUTPUT 2 05S
MTWTFSS ** :15:00
```

State the time of the program using $\uparrow\downarrow$. ** = every hour.
Move to the right using \rightarrow .
Accept using YES.

If the program is approved the text "Program saved" is displayed quickly.

```
WEEK PROGRAM
```

Leave programming by pressing \leftarrow several times.

```
MON 26 SEP 2016
U10:11:00 L12:11
```

WESTERSTRAND URFABRIK AB

P.O. Box 133
SE-545 23 TÖREBODA

Tel. +46 506 48000
Fax. +46 506 48051

Internet: <http://www.westerstrand.se>
E-mail: info@westerstrand.se

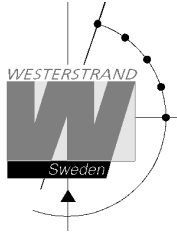

Date Program, example (New program)

Example: Outputs No. 1 shall switch on the 1st of August at 12.00.

MON 26 SEP 2016
U10:11:00 L12:11

Select function using $\uparrow\downarrow$.

DATE PROGRAM

Enter programming mode using YES.

DATE PROGRAM
NEW

Select new program using YES.

OUTPUT 1 ON
AUG 01 08:00:00

Select output using $\uparrow\downarrow$. Move to the right using \rightarrow .

OUTPUT 1 **ON**
AUG 01 08:00:00

State type of signal using $\uparrow\downarrow$.

OUTPUT 1 ON
AUG 01 08:00:00

State the date the program shall function using $\uparrow\downarrow$.
Move to the right using \rightarrow .

OUTPUT 1 ON
AUG 01 **12:00:00**

State the time of the program using $\uparrow\downarrow$.
Move to the right using \rightarrow .
Accept using YES.

If the program is approved the text "Program saved" is displayed quickly.

OUTPUT 1 OFF
AUG 01 12:00:00

Continue with programming OFF for the same output or leave programming by pressing \leftarrow several times.

DATE PROGRAM

MON 26 SEP 2016
U10:11:00 L12:11

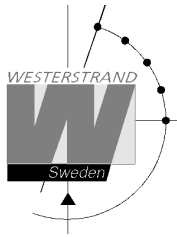

Display Program

MON 26 SEP 2016
U10:11:00 L12:11

Select function using $\uparrow\downarrow$.

DISPLAY PROGRAM

Enter display program using YES.

DISPLAY PROGRAM
GROUP **A**

Select program group using $\uparrow\downarrow$, accept with YES.

GROUP A
OUTPUT **ALL**

Select output to be displayed using $\uparrow\downarrow$, accept with YES.

OUTPUT 2 ON
MTWTF-- 08:00:00

Step forwards alt. Backwards using $\uparrow\downarrow$.

DISPLAY PROGRAM

Leave the function display program by pressing \leftarrow several times.

MON 26 SEP 2016
U10:11:00 L12:11

WESTERSTRAND URFABRIK AB

P.O. Box 133
SE-545 23 TÖREBODA

Tel. +46 506 48000
Fax. +46 506 48051

Internet: <http://www.westerstrand.se>
E-mail: info@westerstrand.se

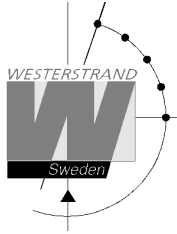

Temporary Program, example

Example: Outputs No. 2 shall switch on immediately 15.35.00 and turn off according to normal week program. The temporary program will automatically be erased when the event has been effected.

MON 26 SEP 2016
U10:11:00 L12:11

Select function using $\uparrow\downarrow$.

TEMPORARY PROGR.

Enter programming mode using YES.

OUTPUT 2 ON
15:35:00

Select output using $\uparrow\downarrow$. Move to the right using \rightarrow .

OUTPUT 2 **ON**
15:35:00

State type of signal using $\uparrow\downarrow$.
Accept using YES

OUTPUT 2 ON
15:35:00

Accept using YES or change the time of the program using $\uparrow\downarrow$.

TEMPORARY PROGR.

Leave the programming by pressing " several times.

MON 26 SEP 2016
U10:11:00 L12:11

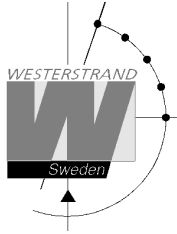

MARINE MASTER CLOCK

User Manual

Document: 1717en19.doc
Author: PM
Date: 2017-12-22
Page: 28 of 51

Group => Period

Each program group can be associated to one or several *time periods*. A time period can consist of one or several dates. Maximum 99 time periods can be used. Program group **A** is as default associated to a time period covering the complete year, 1/1-31/12.

Example:

A school has one group of programs that are used during the school season and another used during school holidays. School season = Group **A**, School holidays = Group **B**.

The school holidays are at the following dates: 1/5, 10/6-15/8, 23/9 and so on...

```
MON 26 SEP 2016
U10:11:00 L12:11
```

Select function using $\uparrow\downarrow$.

```
GROUP => PERIOD
```

Enter programming mode using YES.

```
GROUP B
1:_____ - _____
```

Select group of programs using $\uparrow\downarrow$, accept using YES.

```
GROUP B
1: MAY01 - _____
```

State the date when the period shall begin.
Move to the right using \rightarrow .

```
GROUP B
1: MAY01 - MAY01
```

State the date when the period shall end.
Accept with Yes.

```
GROUP B
2:_____ - _____
```

Continue with next time period.

```
GROUP B
2: JUN07 - _____
```

```
GROUP B
2: JUN07 - AUG15
```

Accept with YES.

```
GROUP => PERIOD
```

Continue with next time period or leave programming by pressing \leftarrow several times.

```
MON 26 SEP 2016
U10:11:00 L12:11
```

WESTERSTRAND URFABRIK AB

P.O. Box 133
SE-545 23 TÖREBODA

Tel. +46 506 48000
Fax. +46 506 48051

Internet: <http://www.westerstrand.se>
E-mail: info@westerstrand.se

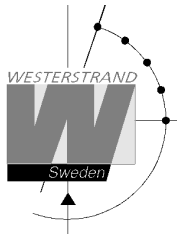

Spec.-Functions

The special functions contain functions used during setup and configuration of the Master Clock. If the default settings are used no configuration is needed.

MON 26 SEP 2016 U10:11:35 L12:11	Select function using ↓ .
SPEC.-FUNCTIONS	Accept with YES.
SPEC.-FUNCTIONS STATUS	Press NO until wished function is shown. Accept with YES.
STATUS	Show status information of the different output/ input in the Master Clock.
LANGUAGE	Language selection.
SETUP	Setup / configuration of the different impulse system, type of synchronisation etc.
DISPLAY FORMAT	Display format in running mode.
SOFTWARE VERSION	Present software version.
DEFAULT LT ADJ.	Default value used when pressing button ADV or REV.
SPEC.-FUNCTIONS STATUS	Return to running mode press ←.
MON 26 SEP 2016 U10:11:35 L12:11	

WESTERSTRAND URFABRIK AB

P.O. Box 133
SE-545 23 TÖREBODA

Tel. +46 506 48000
Fax. +46 506 48051

Internet: <http://www.westerstrand.se>
E-mail: info@westerstrand.se

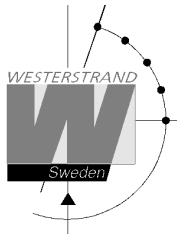

Status

With this function each input/output status can be checked.

Example:

Check the status of the synchronisation source receiver.

MON 26 SEP 2016 U10:11:35 L12:11	Select function using ↓ .
SPEC.-FUNCTIONS	Accept with YES. Press NO until wished function is shown.
SPEC.-FUNCTIONS STATUS	Accept with YES.
STATUS SYNC.SOURCE	Press NO until wished input/output is shown. Accept with YES.
NMEA RS485 60% 14OCT 19:59:00	The Master Clock has accepted 60% of the synchronisation messages. Last reception was 14/10 19:59:00.
STATUS SYNC.SOURCE	Return to running mode press ←.
SPEC.-FUNCTIONS STATUS	←
SPEC.-FUNCTIONS	←
MON 26 SEP 2016 U10:11:35 L12:11	

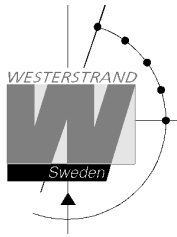

MARINE MASTER CLOCK User Manual

Document: 1717en19.doc
Author: PM
Date: 2017-12-22
Page: 31 of 51

Status sync. source

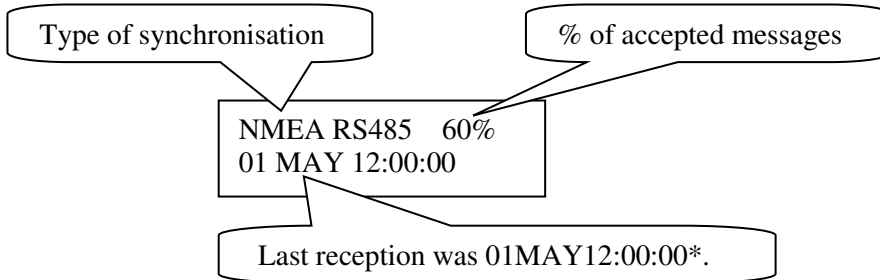

*Remark: For W-GPS the marked position always shows the actual second. This information is updated every other second.

Status impulse output

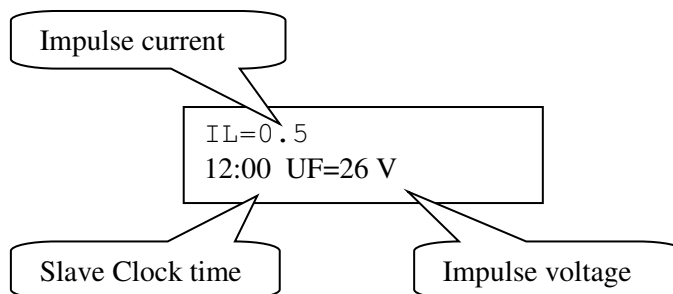

WESTERSTRAND URFABRIK AB

P.O. Box 133
SE-545 23 TÖREBODA

Tel. +46 506 48000
Fax. +46 506 48051

Internet: <http://www.westerstrand.se>
E-mail: info@westerstrand.se

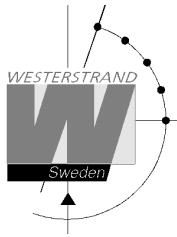

Language

With this function the language be selected.

Example:

MON 26 SEP 2016 U10:11:35 L12:11	Select function using ↓ .
SPEC.-FUNCTIONS	Accept with YES. Press NO until wished function is shown.
SPEC.-FUNCTIONS LANGUAGE	Accept with YES.
LANGUAGE ENGLISH?	Select, by using the arrows, the wished language. Accept with YES.
SPEC.-FUNCTIONS LANGUAGE	Return to running mode press ←.
MON 26 SEP 2016 U10:11:35 L12:11	

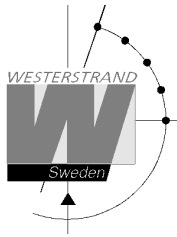

MARINE MASTER CLOCK

User Manual

Document: 1717en19.doc
Author: PM
Date: 2017-12-22
Page: 33 of 51

Setup

With this function the different output and input can be configured. If the default setup is used no configuration is needed.

Example:

Set the alarm limit for *synchronisation source alarm* to 1 hour. (Default setting is 12 hours.)

MON 26 SEP 2016 U10:11:35 L12:11	Select function using ↓ .
SPEC.-FUNCTIONS	Accept with YES. Press NO until wished function is shown.
SPEC.-FUNCTIONS SETUP	Accept with YES.
SETUP SYNC SOURCE	Press NO until wished input/output is shown. Accept with YES.
NMEA RS485 AL.LIMIT --h -- m	Set, by using the arrows, the alarm limit to 1 hour (01h).
NMEA RS485 AL.LIMIT 01h 00 m	Accept with YES
SETUP SYNC SOURCE	Return to running mode press ←.
SPEC.-FUNCTIONS SETUP	←
SPEC.-FUNCTIONS	←
MON 26 SEP 2016 U10:11:35 L12:11	

WESTERSTRAND URFABRIK AB

P.O. Box 133
SE-545 23 TÖREBODA

Tel. +46 506 48000
Fax. +46 506 48051

Internet: <http://www.westerstrand.se>
E-mail: info@westerstrand.se

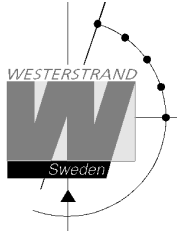

Setup sync. source

Below is a description of the different configuration parameters available in the setup menu for *sync. source*. Please remark that if default settings are used no configuration is needed.

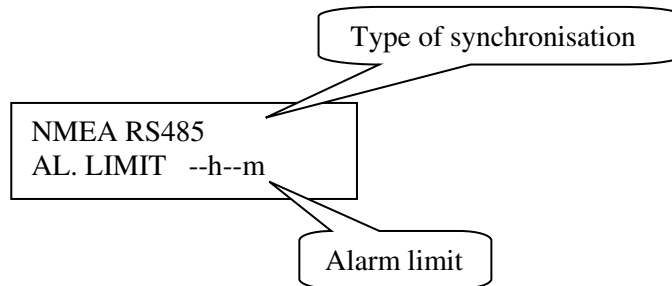

Type of synchronisation

State type of external synchronisation. The following time sources can be selected:

NMEA RS485 (default)	Synchronisation using RS485 input and NMEA ZDA protocol.
NMEA RS232	Synchronisation using RS232 input and NMEA ZDA protocol.
W-GPS	Radio synchronisation GPS type Westerstrand.
DCF77	Radio synchronisation DCF77.
TC	Time code type hard wired DC
-----	No external synchronisation

Alarm limit

The configuration parameter *Alarm limit* specifies the time delay before the radio alarm is activated. Default setting is that the radio alarm is inactivated, AL.LIMIT --h--m.

WESTERSTRAND URFABRIK AB

P.O. Box 133
SE-545 23 TÖREBODA

Tel. +46 506 48000
Fax. +46 506 48051

Internet: <http://www.westerstrand.se>
E-mail: info@westerstrand.se

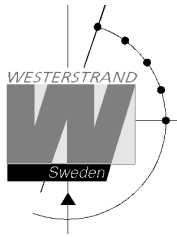

Setup impulse output

Below is a description of the different configuration parameters available in the setup menu for *impulse output*. Please remark that if default settings are used no configuration is needed.

Impulse type

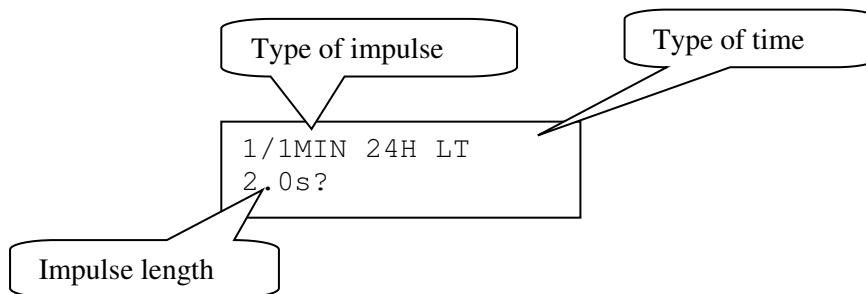

Type of impulse

Selection of impulse type. The following types are available.

1/1M-24H	: Polarised 1/1-minute impulse with 24 hours resetting
1/1M-12H	: Polarised 1/1-minute impulse with 12 hours resetting.
1/2M-24H	: Polarised 1/2-minute impulse with 24 hours resetting
1/2M-12H	: Polarised 1/2-minute impulse with 12 hours resetting.
SEC-12H	: Polarised Second impulses with 12 hours resetting.
SEC-60S	: Polarised Second impulses with 60 seconds resetting.
1/2-SEC	: Polarised Second impulses with 60 seconds resetting.
TCmarine	: Time Code marine
TC-ext	: Time Code marine for TC-Clocks diameter 600-900 mm.
FW/RW	: 3-wire for Forward/Reverse, 1/1-minute.
FW/RW1/2	: 3-wire for Forward/Reverse, 1/2-minute.
1/1M-SS	: Polarised 1/1-minute impulse for analogue clocks with sweeping second hand. (2 seconds pulse length in normal mode and 0.5 seconds during correction)
1/2M-12B	: Clock signal to Telegraph Logger
-----	: No impulse system.

Type of time

LT = Local Time.

UTC = Universal Time Coordinated.

WESTERSTRAND URFABRIK AB

P.O. Box 133
SE-545 23 TÖREBODA

Tel. +46 506 48000
Fax. +46 506 48051

Internet: <http://www.westerstrand.se>
E-mail: info@westerstrand.se

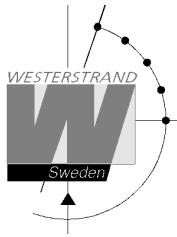

Impulse length

Configuration of impulse length.

1/1 and 1/2 -minute impulse: 0.1 s – 9.9 s.
Second impulses: 0.1 – 1.0 s.

Alarm limits

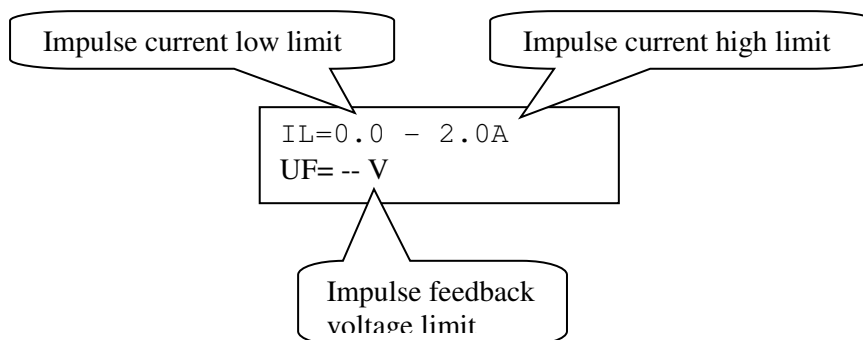

Impulse current low limit

Alarm limit for low current (minimum load). The minimum load can be set from 0A up to 2.0A.

Impulse current high limit

Alarm limit for high current (maximum load). The maximum load can be set from 0A up to 2.0A.

Impulse feedback voltage limit

Alarm limit for feedback impulse voltage.

-- : No limit (default).
01 - 99 : Limit in volts, V.

WESTERSTRAND URFABRIK AB

P.O. Box 133
SE-545 23 TÖREBODA

Tel. +46 506 48000
Fax. +46 506 48051

Internet: <http://www.westerstrand.se>
E-mail: info@westerstrand.se

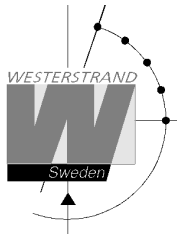

Setup RS232 and RS485/422 output / input

Below is a description of the different configuration parameters available in the setup menu for the **RS232 and RS485 input/output**.

Please remark that if default settings are used no configuration is needed. The RS485/422 input protocol is always fixed to NMEA ZDA Time string and cannot be changed.

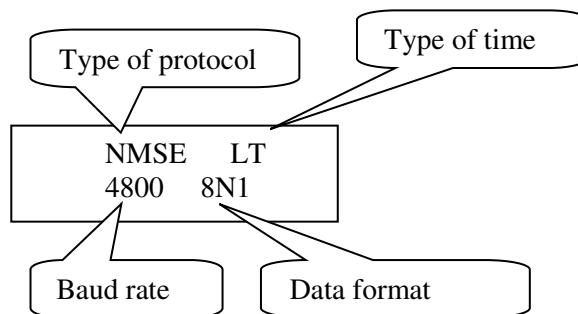

Type of protocol

Name of the transmission / reception protocol used in the module. The following protocols are available.

NMEA output from Master Clock

NMMI: NMEA 0183, ZDA Time string, minute update, without hundreds of seconds
NMSE: NMEA 0183, ZDA Time string, second update, without hundreds of seconds
NMMC: NMEA 0183, ZDA Time string, minute update, with hundreds of seconds
NMSC: NMEA 0183, ZDA Time string, second update, with hundreds of seconds

NMin NMEA 0183, ZDA Time string, (input to Master Clock)

Other protocols

1: General 2-way-communication protocol.
2, 3, 5, 7, 16 etc.: Automatic time message protocols.

Type of time

Type of time received or transmitted.

LT = Local Time.

UTC = Universal Time Coordinated.

Baudrate

Available speeds: 300, 600, 1200, 2400, 4800, 9600 baud.

Data format

Data format of message received or transmitted.

No. of data bits, 7 or 8.

Type of parity, none, odd or even.

WESTERSTRAND URFABRIK AB

P.O. Box 133
SE-545 23 TÖREBODA

Tel. +46 506 48000
Fax. +46 506 48051

Internet: <http://www.westerstrand.se>
E-mail: info@westerstrand.se

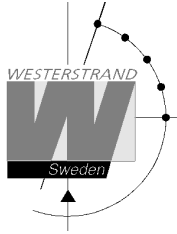

MARINE MASTER CLOCK

User Manual

Document: 1717en19.doc
Author: PM
Date: 2017-12-22
Page: 38 of 51

No. of stop bits, 1 or 2.

Available formats:

7N1, 7N2, 7O1, 7O2, 7E1, 7E2, 8N1, 8N2, 8O1, 8O2, 8E1, 8E2,

Protocol description

ZDA - Time & Date - UTC, Day, Month, Year and Local Time Zone

1	2	3	4	5	6	7

\$--ZDA, hhmmss.ss, xx, xx, xxxx, xx, xx*hh<CR><LF>

Field Number:

- 1) Universal Time Coordinated (UTC)
- 2) Day, 01 to 31
- 3) Month, 01 to 12
- 4) Year
- 5) Local zone description, 00 to +- 13 hours
- 6) Local zone minutes description, same sign as local hours
- 7) Checksum

WESTERSTRAND URFABRIK AB

P.O. Box 133
SE-545 23 TÖREBODA

Tel. +46 506 48000
Fax. +46 506 48051

Internet: <http://www.westerstrand.se>
E-mail: info@westerstrand.se

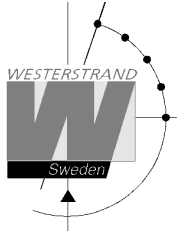

MARINE MASTER CLOCK User Manual

Document: 1717en19.doc
Author: PM
Date: 2017-12-22
Page: 39 of 51

Protocol 2

The message has length 20 bytes according to:

STX F G W 20 YY MM DD HH MM SS ETX BCC

F - Flag bits

7	=0
6	=1
5	=0
4	=0 Winter time, =1 summer time
3	=1 Synced from Radio source, e.g. DCF77
2	=1 Synced from timeserver
1	0 Type of time
OFF OFF	UTC
OFF ON	LOC
ON OFF	NOR

Example:

Assume wintertime time, synched from radio source, synchronized from timeserver, local time:
Bits 6, 3, 2 and 0 are set: 0100 1101 = 4Dh = 'M'

G - UTC offset during wintertime from letter 'P' in 1/2 hour steps.

Example:

Germany 2 x 1/2 = 1 hour, so 'P'+2 = 'R'

W	Weekday	'1' Monday .. '7' Sunday
YY	Year	'00'..'99'
MM	Month	'01'..'12'
DD	Day of month	'01'..'31'
HH	Hour	'00'..'23'
MM	Minute	'00'..'59'
SS	Second	'00'..'59'
ETX	03h	
BCC	Exclusive or of bytes F..ETX	

The message is transmitted each second

WESTERSTRAND URFABRIK AB

P.O. Box 133
SE-545 23 TÖREBODA

Tel. +46 506 48000
Fax. +46 506 48051

Internet: <http://www.westerstrand.se>
E-mail: info@westerstrand.se

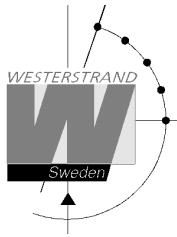

MARINE MASTER CLOCK

User Manual

Document: 1717en19.doc
Author: PM
Date: 2017-12-22
Page: 40 of 51

Protocol 3

At second 56 this message will be transmitted:

HH:MM:00 SP DD/MN/YY SP NNN SP W CR LF (25 bytes)

HH = Hour '00' - '23'.
: = 3AH
MM = Minute '00' - '59'.
SP = Blank 20H.
DD = Date '01' - '31'.
/ = 2FH
MN = Month '01' - '12'.
YY = Year '00' - '99'.
NNN = Daynumber '001' - '365' (3 bytes).
W = Weekday '1' - '7'.
CR = 0DH.
LF = 0AH.

At second 60 (0) a synchronisation sign SUB (1AH) is transmitted.

Remark: The message transmitted at second 56 is *next* minute.

Example:

At 09:07:56 is a message transmitted. The time included in this message will be 09:08:00.

Protocol 5

T:YY:MN:DD:WW:HH:MM:SS CR LF (24 bytes)

T = T
: = 3AH
YY = Year 00....99
MN = Month 01....12
DD = Day 01....31
WW = Day of week 01....07
HH = Hour 00....23
mm = Minutes 00....59
ss = Seconds 00....59
CR = Carriage return 0Dh.
LF = Line feed 0Ah.

The time message is sent out each minute or each second.

WESTERSTRAND URFABRIK AB

P.O. Box 133
SE-545 23 TÖREBODA

Tel. +46 506 48000
Fax. +46 506 48051

Internet: <http://www.westerstrand.se>
E-mail: info@westerstrand.se

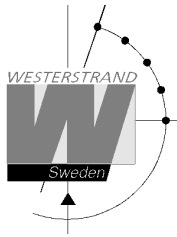

MARINE MASTER CLOCK User Manual

Document: 1717en19.doc
Author: PM
Date: 2017-12-22
Page: 41 of 51

Protocol 7

STX WW VV YYYY MN DD HH MM SS F G BCC ETX (24 bytes)

STX = 02h (1 byte).

WW = Week number '01'-'53'
VV = Weekday '01'-'07'
YYYY = Year '2003-2099'
MN = Month '01'-'12'
DD = Day '01'-'31'
HH = Hour '00'-'23'
MM = Minute '00'-'59'
SS = Second '00'-'59'

F = '0' Winter-time.
= '1' Summer-time.

G = Offset to UTC for winter-time according to (1 byte):
' ,' (2Ch) -2 hours, '.' (2Eh) -1 hour, '0' (30h) 0 hour.

BCC = Checksum; Exclusive OR of bytes WW..F G in hexadecimal ascii format (2 bytes). Byte STX is NOT included!.

ETX = 03h (1 byte).

This message is sent out each second.

WESTERSTRAND URFABRIK AB

P.O. Box 133
SE-545 23 TÖREBODA

Tel. +46 506 48000
Fax. +46 506 48051

Internet: <http://www.westerstrand.se>
E-mail: info@westerstrand.se

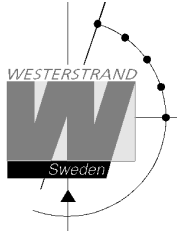

MARINE MASTER CLOCK

User Manual

Document: 1717en19.doc
Author: PM
Date: 2017-12-22
Page: 42 of 51

Protocol 16*

STC HH MM SS DD MO MO YY HL HL ML ML ECT

Code	description	Hex value
STC	Start Transmission Character	02
H	Ten UTC hours	30-32
H	Unit UTC hours	30-39
M	Ten UTC minutes	30-35
M	Unit UTC minutes	30-39
S	Ten UTC seconds	30-35
S	Unit UTC seconds	30-39
D	Ten date UTC	30-33
D	Unit date UTC	30-39
MO	Ten month UTC	30-31
MO	Unit month UTC	30-39
Y	Ten year UTC	30-39
Y	Unit year UTC	30-39
HL	Ten LT hours	30-32
HL	Unit LT hours	30-39
ML	Ten LT minutes	30-35
ML	Unit LT minutes	30-39
ECT	End transmission character	03

* Protocol 16M = Message transmitted each minute.

* Protocol 16S = Message transmitted each second.

WESTERSTRAND URFABRIK AB

P.O. Box 133
SE-545 23 TÖREBODA

Tel. +46 506 48000
Fax. +46 506 48051

Internet: <http://www.westerstrand.se>
E-mail: info@westerstrand.se

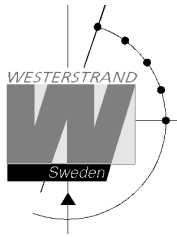

MARINE MASTER CLOCK

User Manual

Document: 1717en19.doc
Author: PM
Date: 2017-12-22
Page: 43 of 51

Setup special pulse

Relay output no. 2 can be dedicated to send out a special pulse. When this function is enabled the relay is activated every day for 5 seconds at 02.00 UTC.

Use the procedure below to enable the special pulse.

MON 26 SEP 2016
U10:11:35 L12:11

Select function using ↓ .

SPEC.-FUNCTIONS

Accept with YES.
Press NO until wished function is shown.

SPEC.-FUNCTIONS
SETUP

Accept with YES.

SETUP
SPECIAL PULSE

Press NO until wished input/output is shown.
Accept with YES.

SPECIAL PULSE
NO ?

Change to using ↑↓.

SPECIAL PULSE
YES ?

Accept with YES

SETUP
SPECIAL PULSE

Return to running mode press ←.

SPEC.-FUNCTIONS
SETUP

←

SPEC.-FUNCTIONS

←

MON 26 SEP 2016
U10:11:35 L12:11

WESTERSTRAND URFABRIK AB

P.O. Box 133
SE-545 23 TÖREBODA

Tel. +46 506 48000
Fax. +46 506 48051

Internet: <http://www.westerstrand.se>
E-mail: info@westerstrand.se

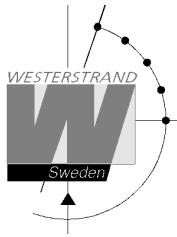

Setup NMEA LT

This function is valid only if the Master Clock is synchronised from an external NMEA source. Special function sync. source must be set to NMEA RS485 or NMEA RS232.

With this function it can be selected if the Master Clock should use the Local Time (LT) information included in the NMEA time message. The Master Clocks LT will be set to the nearest time with respect to the default value entered in the special function *DEFAULT LT ADJ.*

Example:

DEFAULT LT ADJ is set to 20 minutes. Local Time is 15:30.

1. Received LT is changed 5 minutes to 15:35, which is closer to 15:30 than 15:50;
Master Clock LT will stay on 15:30.
2. Received LT is changed 10 minutes to 15:40, which is in the middle of 15:30 and 15:50;
Master Clock LT will stay on 15:30.
3. Received LT is changed 15 minutes to 15:45, which is closer to 15:50 than 15:30;
Master Clock LT will change 20 minutes to 15:50.

Default setting is NO, which means that the Local Time information is not used.

Use the procedure below to change the setting.

MON 26 SEP 2016 U10:11:35 L12:11	Select function using ↓.
SPEC.-FUNCTIONS	Accept with YES.
SPEC.-FUNCTIONS SETUP	Press NO until wished function is shown. Accept with YES.
SETUP NMEA LT	Press NO until wished input/output is shown. Accept with YES.
NMEA LT NO ?	Change to using ↑↓.
NMEA LT YES ?	Accept with YES
SETUP NMEA LT	Return to running mode press ←.

WESTERSTRAND URFABRIK AB

P.O. Box 133
SE-545 23 TÖREBODA

Tel. +46 506 48000
Fax. +46 506 48051

Internet: <http://www.westerstrand.se>
E-mail: info@westerstrand.se

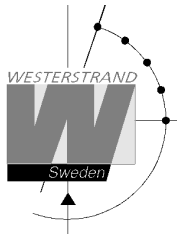

MARINE MASTER CLOCK

User Manual

Document: 1717en19.doc
Author: PM
Date: 2017-12-22
Page: 45 of 51

SPEC.-FUNCTIONS SETUP	←
SPEC.-FUNCTIONS	←
MON 26 SEP 2016 U10:11:35 L12:11	

Software version

This function shows the software version for the Time Base module.

MON 26 SEP 2016 U10:11:35 L12:11	Select function using ↓.
SPEC.-FUNCTIONS	Accept with YES. Press NO until wished function is shown.
SPEC.-FUNCTIONS SOFTWARE VERSION	Accept with YES.
MMC-A127 11m	The software version is MMC-A127. 11m = Uptime for this Master Clock.
SPEC.-FUNCTIONS SOFTWARE VERSION	Return to running mode press ←.
SPEC.-FUNCTIONS	←
MON 26 SEP 2016 U10:11:35 L12:11	

WESTERSTRAND URFABRIK AB

P.O. Box 133
SE-545 23 TÖREBODA

Tel. +46 506 48000
Fax. +46 506 48051

Internet: <http://www.westerstrand.se>
E-mail: info@westerstrand.se

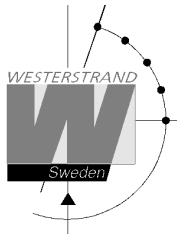

Default LT adjust

This function is used to enter the default value used when pressing button ADV or REV.

Example:

Change default LT adj. from 60 minutes to 20 minutes.

MON 26 SEP 2016 U10:11:35 L12:11	Select function using ↓.
SPEC.-FUNCTIONS	Accept with YES. Press NO until wished function is shown.
SPEC.-FUNCTIONS DEFAULT LT ADJ.	Accept with YES.
DEFAULT LT ADJ. 60 m ?	Change to using ↑↓.
DEFAULT LT ADJ. 20 m ?	Accept with YES.
SPEC.-FUNCTIONS DEFAULT LT ADJ.	Return to running mode press ←.
SPEC.-FUNCTIONS	←
MON 26 SEP 2016 U10:11:35 L12:11	

WESTERSTRAND URFABRIK AB

P.O. Box 133
SE-545 23 TÖREBODA

Tel. +46 506 48000
Fax. +46 506 48051

Internet: <http://www.westerstrand.se>
E-mail: info@westerstrand.se

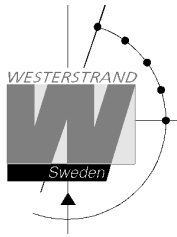

MARINE MASTER CLOCK User Manual

Document: 1717en19.doc
Author: PM
Date: 2017-12-22
Page: 47 of 51

Display format

With this function the display format in running mode can be selected.

The following three formats can be selected:

MON 26 SEP 2016 10:11:00 LT	Format 1 LT = Local Time. UTC = Universal Time Coordinated.
MON 26 SEP 2016 U10:11:00 L12:11	Format 2 (Default) L = Local Time U = UTC
MON 26 SEP 2016 LT	Format 3, Used for test / fault finding.

Example:

MON 26 SEP 2016 U10:11:35 L12:11	Select function using ↓ .
SPEC.-FUNCTIONS	Accept with YES. Press NO until wished function is shown.
SPEC.-FUNCTIONS DISPLAY FORMAT	Accept with YES.
DISPLAY FORMAT -1- LT	Select, by using the arrows, the wished display format. Accept with YES.
SPEC.-FUNCTIONS DISPLAY FORMAT	Return to running mode press ←.
MON 26 SEP 2016 12:11:00 LT	

WESTERSTRAND URFABRIK AB

P.O. Box 133
SE-545 23 TÖREBODA

Tel. +46 506 48000
Fax. +46 506 48051

Internet: <http://www.westerstrand.se>
E-mail: info@westerstrand.se

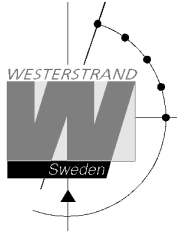

MARINE MASTER CLOCK
User Manual

Document: 1717en19.doc
Author: PM
Date: 2017-12-22
Page: 48 of 51

Programming form

Function	Group	Output no.	Type of signal	Day/Date	Time

WESTERSTRAND URFABRIK AB

P.O. Box 133
SE-545 23 TÖREBODA

Tel. +46 506 48000
Fax. +46 506 48051

Internet: <http://www.westerstrand.se>
E-mail: info@westerstrand.se

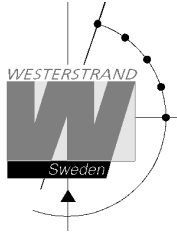

Fault tracing

The display is blank

- A. The green LED "POWER" is light?
 - A1. No.
 - A1A. Check the supply voltage.
 - A1B. Power supply wires connected correctly?
 - A2. Yes.
 - A2A. Restart the master clock by switching the supply voltage off and on.

After starting up the master clock, no impulses appear (to correct the slave clocks).

- B1. The master clock awaits the time shown by the slave clocks. Impulses will be distributed when correct time = the time shown by the slave clocks.

Relay outputs are programmed but nothing happens.

- C1. The switch on the front panel is in position **0**. Correct position is **A**.
- C2. Check that the output is working when the switch is in position **1**.
- C3. Different program types have different priority. E.g. a programmed date program overrides a signal point in a week program.
Priority order (1=highest, 3=lowest):
1) Date program 2) Group 3) Week program

Alarm messages

- D1. "Short circuit"

Excessive load on the impulse output. Check the slave clock wiring. Impulses are stored (memorised) during the alarm. When the fault is fixed, all the stored impulses are distributed by rapid impulsing.

- D2. "Memory full"

The master clock is out of memory, probably due to incorrect programming. Use week program for repetitive signals or group for a certain period. See the programming instructions in this manual.

WESTERSTRAND URFABRIK AB

P.O. Box 133
SE-545 23 TÖREBODA

Tel. +46 506 48000
Fax. +46 506 48051

Internet: <http://www.westerstrand.se>
E-mail: info@westerstrand.se

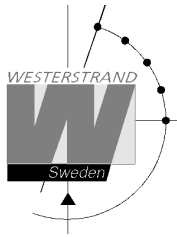

D3. “Exists”

The signal point is already programmed.

D4. “Not programmed”

When trying to change a non-existing signal point.

Alarm output

The Master Clock is equipped with two separate alarm relays. One relay for general alarm and one for power failure alarm. See alarm list on page 16 for details.

<i>General alarm</i>	1 - 2	1 - 3		
Normal mode, no alarm	Open	Closed		
Overload/short circuit alarm	Closed	Open		
Synchronisation alarm	Closed	Open		
<i>Power alarm</i>	8 - 9	8 - 10		
Normal mode, no alarm	Open	Closed		
Power failure alarm	Closed	Open		

General alarm relay

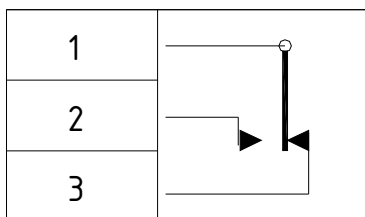

Power alarm relay

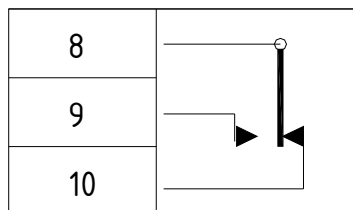

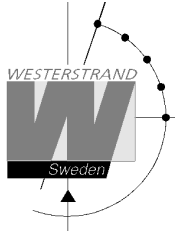

MARINE MASTER CLOCK User Manual

Document: 1717en19.doc
 Author: PM
 Date: 2017-12-22
 Page: 51 of 51

Connection diagram

This publication is issued to provide outline information only. The Company reserves the right to alter without notice the specifications, design or conditions of supply of any product of service. Information on this publication supersedes all previous information.

CONNECTION PLATE

05 (2-WIRE)		06		07	
PIN NO.	SIGNAL	PIN NO.	SIGNAL	PIN NO.	SIGNAL
1	IMPULSE 4A	1	ALARM RELAY OUTPUT	1	24VDC
2	IMPULSE 4B	2	PROGRAM RELAY OUTPUT	2	SIGNAL +24
3	NO CONNECTION	3		3	0V
4	IMPULSE 4A	4			
5	IMPULSE 4B	5			
6	NO CONNECTION	6			
7	IMPULSE 4A	7			
8	IMPULSE 4B	8			
9	NO CONNECTION	9			
10	IMPULSE 4A	10			
11	IMPULSE 4B	11			
12	NO CONNECTION	12			

05 (3-WIRE)		08	
PIN NO.	SIGNAL	PIN NO.	SIGNAL
1	LT FORWARD	1	85-264VAC
2	LT COMMON	2	SIGNAL L
3	LT REVERSE	3	SIGNAL N
4	LT FORWARD	3	PE
5	LT COMMON		
6	LT REVERSE		
7	LT FORWARD		
8	LT COMMON		
9	LT REVERSE		
10	LT FORWARD		
11	LT COMMON		
12	LT REVERSE		

04		REMARK	
PIN NO.	SIGNAL		
1	IMPULSE 1A	IMPULSE OUTPUT NO. 1	
2	IMPULSE 1B		
3	IMPULSE 1A		
4	IMPULSE 1B		
5	IMPULSE 2A	IMPULSE OUTPUT NO. 2	
6	IMPULSE 2B		
7	IMPULSE 2A		
8	IMPULSE 2B		
9	IMPULSE 3A	IMPULSE OUTPUT NO. 3	
10	IMPULSE 3B		
11	IMPULSE 3A		
12	IMPULSE 3B		

01		REMARK	
PIN NO.	SIGNAL		
1	CHASSIS GND	RS485	
2	-Rx RS485	NMEA INPUT	
3	+Rx RS485		
4	CHASSIS GND	RS485 OUTPUT	
5	-Tx RS485		
6	+Tx RS485		
7	NC	NO CONNECTION	
8	GND	GPS RECEIVER	
9	+		
10	DCF		
11	+24	24V DC OUT	
12	0V		

02 (OPTION)		REMARK	
PIN NO.	SIGNAL		
2	Rx RS232	RS232 INPUT	
3	Tx RS232	RS232 OUTPUT	
5	GND RS232	SIGNAL GND	

03		REMARK	
PIN NO.	SIGNAL		
1	1	9-POL D-SUB MALE	
2	2		
3	3		
5	5		

03		REMARK	
PIN NO.	SIGNAL		
2	Rx RS232	RS232 INPUT	
3	Tx RS232	RS232 OUTPUT	
5	GND RS232	SIGNAL GND	

07		REMARK	
PIN NO.	SIGNAL		
1	24VDC	ALARM RELAY OUTPUT	
2	SIGNAL +24	PROGRAM RELAY OUTPUT	
3	0V		
		POWER FAILURE ALARM RELAY OUTPUT	

08		REMARK	
PIN NO.	SIGNAL		
1	85-264VAC		
2	SIGNAL L		
3	SIGNAL N		
		PE	

02 (OPTION)		REMARK	
PIN NO.	SIGNAL		
1	Rx+		
2	Rx-		
3	Tx+		
6	Tx-		

CONNECTION DRAWING	
Date	Title/Name
2016-10-10	Marine master Clock
Designed by PM	Owner: Westerstrand Urfabrik AB
Scale	Drawing number 084550-00
	Toreboda - Sweden
Edition 7, connector 02 moved, 2016-10-10 PM	Sheet A3
Edition 6, RS485 +/- switched, 2011-09-06 PM	Edition 7
	1 (1)

WESTERSTRAND URFABRIK AB

P.O. Box 133
 SE-545 23 TÖREBODA

Tel. +46 506 48000
 Fax. +46 506 48051

Internet: <http://www.westerstrand.se>
 E-mail: info@westerstrand.se