

Manual

Operation digital clock with Chronometer function

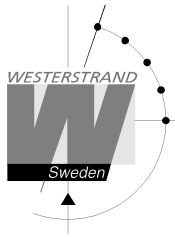

General

This chronometer has a LED-display, for use alternatively as digital clock or as chronometer.

Digital clock for indoor application has 4 digits and colon displaying time.

Digital clock for indoor application with second has 6 digits and colon displaying time.

Example

23:59:48

The Digital clock can be programmed for alternating time/date/temperature display in 0-25 sec intervals.

Temperature sensor is not included. It is an option.

The programming of time, Synchronisation and light intensity are made by push buttons.

The digital clock can operate stand alone with a built in quartz crystal as time reference, as a slave clock to a master clock transmitting 24 V polarised 1/1 minute impulses or synchronised by TC, DCF. If the DLS-function is set, the clock is changing, summer and winter time, the last Sunday in March and the last Sunday in October automatically.

The clock has adjustable light intensity.

If power failure occurs the display is turned off. The internal clock continues to keep the correct time for 48 hours. After power failure the display is turned on and correct time is shown.

If not specified in order the clocks are preset from factory in impulse Synchronisation mode.

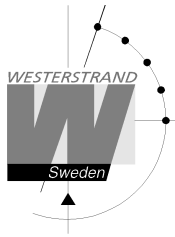

Connection

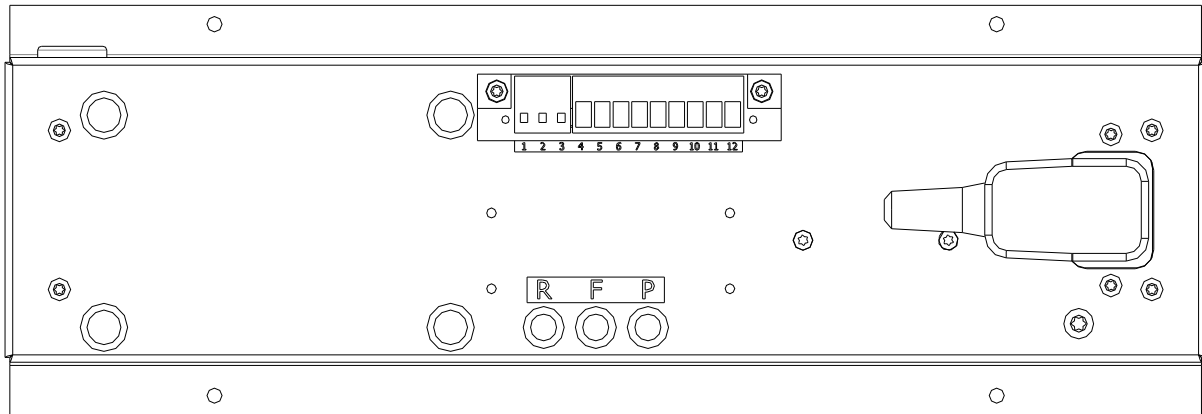

Connection Synchronisation wire

TC/MIN-imp 2,3

DCF 2-line 3- V+, 1 – GND

DCF 3-line 3- V+, 2- DCF, 1 – GND

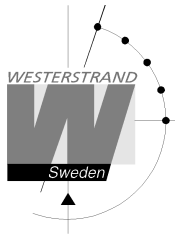

Connection chronometer with standard control unit

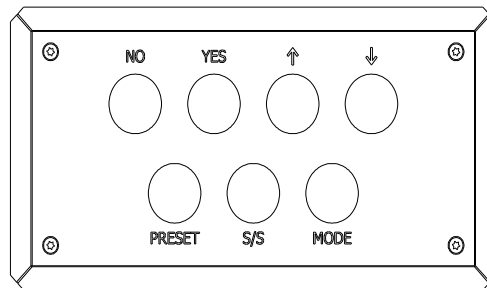
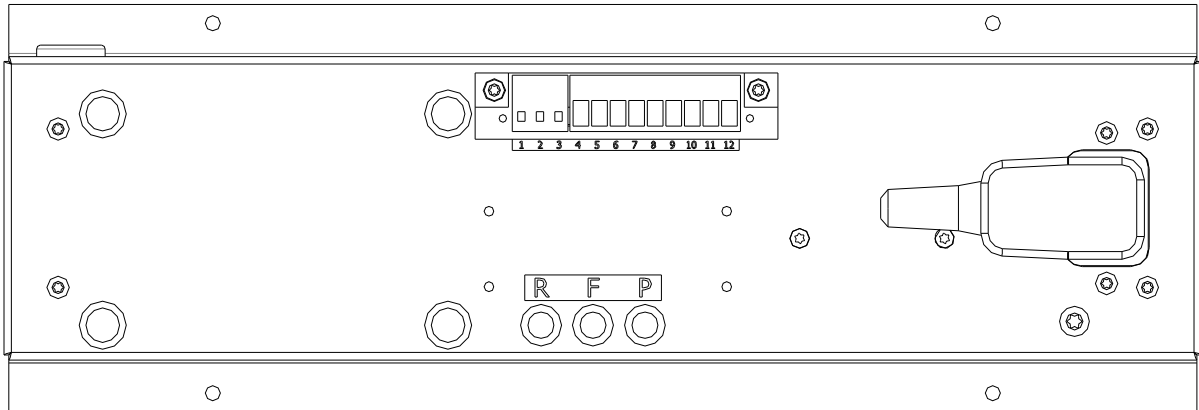

CONTROL UNIT

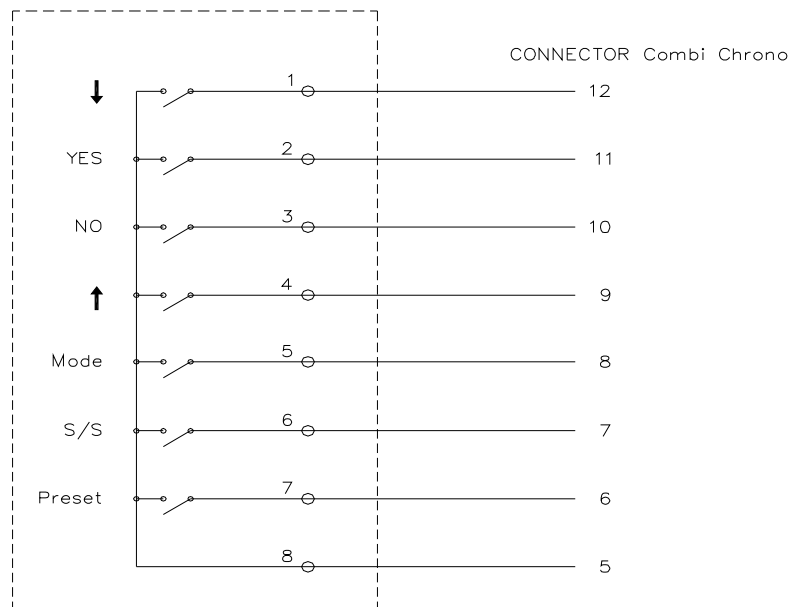

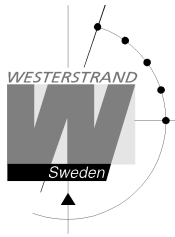

Connection chronometer with option control unit

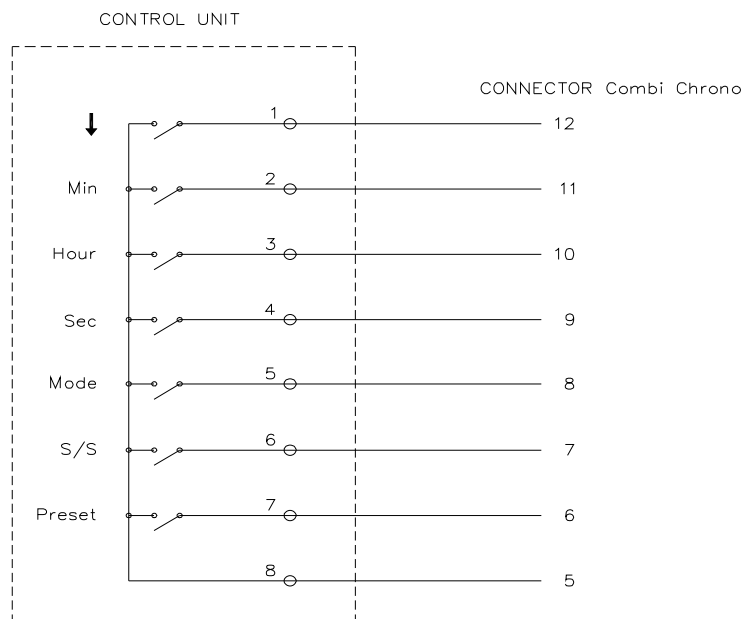
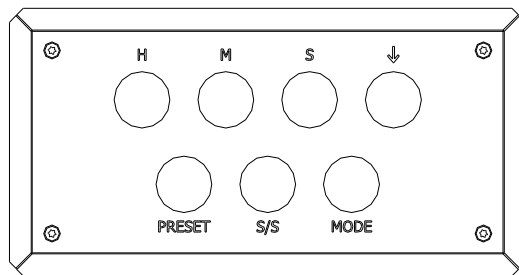
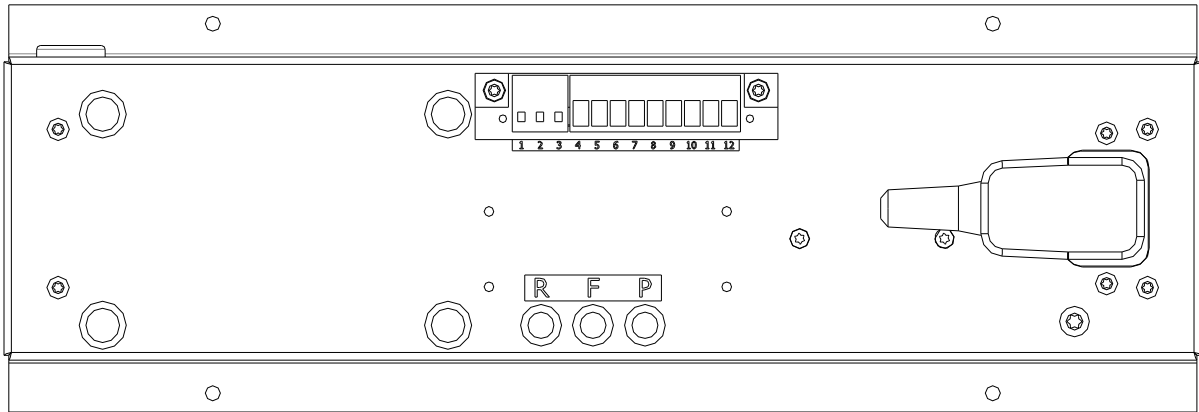

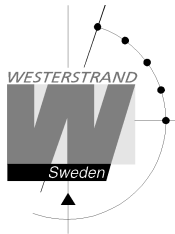

Strapping/DIP switch setting for TC / MIN-impulse (default)

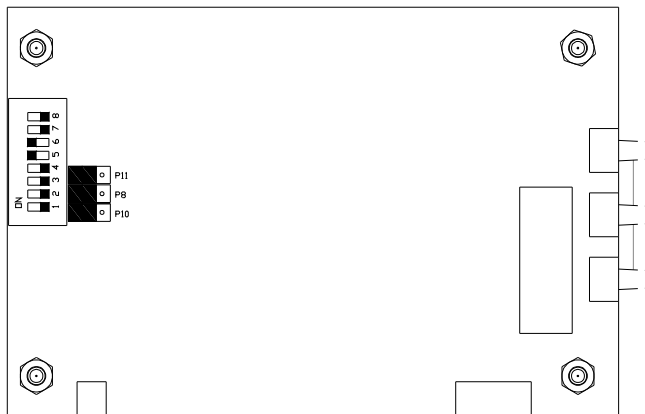

Note!
If ½ minute impulse the DIP switch no. 5 will be off.

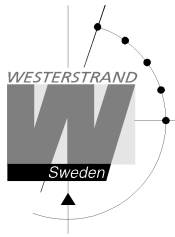

Strapping/DIP switch setting for DCF-radio (2 –wire) computer board

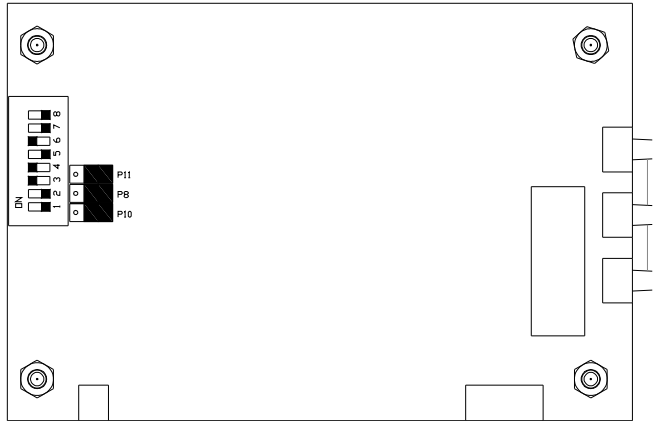

Strapping/DIP switch setting for DCF-radio (3 –wire) computer board

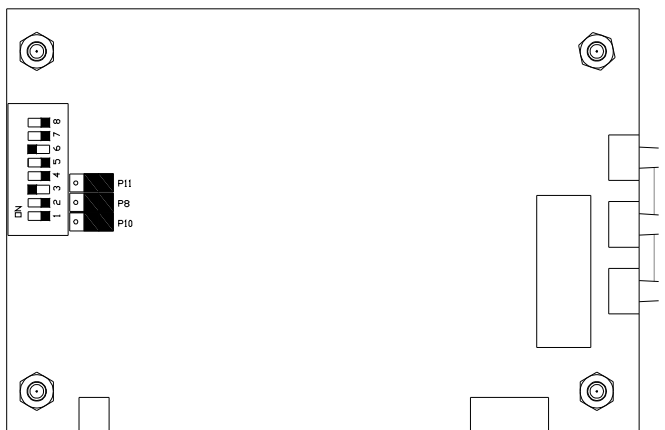

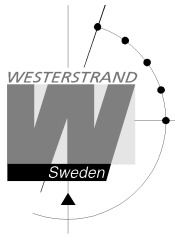

The DIP-switch on the computer board should be set as follows:

Dip 1: OFF	Display format is HH:MM.
ON	Display format is HH:MM:SS.
Dip 2: OFF	always OFF
Dip 3: OFF	TC/Min impulse synchronisation. (default)
ON	DCF synchronisation.
Dip 4: OFF	TC/Min impulse or 3-wire DCF synchronisation. (default)
ON	2-wire DCF synchronisation.
Dip 5: OFF	DCF synchronisation.
ON	TC/Min impulse synchronisation.(default)
Dip 6: OFF	½ Min impulse synchronisation.
ON	TC/Min impulse synchronisation or DCF synchronisation. (default)
Dip 7: OFF	always OFF
Dip 8: OFF	always OFF

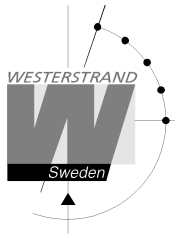

Synchronisation

Stand alone

If the clock does not have an external synchronisation, it operates Stand alone.

Minute impulse

Make the strapping according to the drawing for strapping page 6.

Connect the minute impulse wire according to the schema page 3.

The clock can be set in synchronisation or slave mode.

Synchronisation mode:

Set the clock for synchronisation, mode InSy See programming page 11.

Set time and wait for next minute impulse. The clock will be synchronised

Slave mode:

Set the clock for slave, mode InSL See programming page 11.

Set time and wait for next minute impulse. The clock operates as a slave clock.

TC

Check the strapping according to the drawing for strapping page 6.

Connect the TC wire according to the schema page 3.

Set the clock for synchronisation, function DCF See programming page 11.

When a correct time message appears the clock sets the time.

The clock will blink colon when it is in sync and accepts transmitted code.

DCF

Check the strapping according to the drawing for strapping page 6.

Connect the DCF wire according to the schema page 3.

Set the clock for synchronisation, function DCF See programming page 11.

When a correct time message appears, the clock sets the time.

The clock will blink colon when it is in sync and accepts transmitted code.

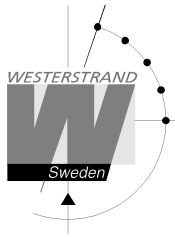

Programming

The programming is made by push buttons (placed on the rear plate).

R (Return) Enter the base mode (display time)

F (Function) Next function / Accept displayed value

P (Program) Enter the displayed function / Increase displayed value.

programming time (If Time Code, TC, is connected no manual time setting is needed.)

Push [F] until display shows

Push [P] display shows year.

Push [P] until desired year (00-99)
Accept with [F].

Display shows month.

Push [P] until desired month (1-12).
Accept with [F].

Display shows day.

Push [P] until desired date (1-31).
Accept with [F].

Display shows hour.

Push [P] until desired hour (0-23). Accept with [F].

Display shows minutes.

Push [P] until desired minute (00-59). Push [F] for synchronisation and the clock starts

Display shows:

Push [R]. The Programming is finished.

Display shows:

WESTERSTRAND URFABRIK AB

P.O. Box 133
SE-545 23 TÖREBODA

Tel. +46 506 48000
Fax. +46 506 48051

Internet: <http://www.westerstrand.se>
E-mail: info@westerstrand.se

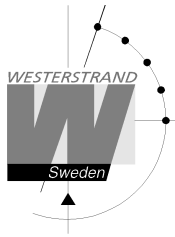

Setting light intensity

The light intensity for the digits can be adjusted in 8 levels.
An automatic dimmer function regulates the light intensity.

Push [F] until display shows.

di sp

Push [P]

Display shows: di 1 . Light intensity 1 (weakest), 8 (strongest).

Push [P] for desired light intensity. Accept with [F].

Display shows

Sy nc

Push [R] for entering base mode or push [F] for next function.

Setting synchronisation

Synchronisation for this model are minute impulse, TC, DCF (or stand alone).

Push [F] until display shows.

Sy nc

Push [P] until desired synchronisation.

no sy

No synchronisation, stand alone.

dcf

TC or DCF.

InSy

Impulse synchronisation.

InSL

Impulse slave.

Push [R] for entering base mode or push [F] for next function.

WESTERSTRAND URFABRIK AB

P.O. Box 133
SE-545 23 TÖREBODA

Tel. +46 506 48000
Fax. +46 506 48051

Internet: <http://www.westerstrand.se>
E-mail: info@westerstrand.se

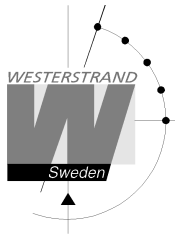

Setting alternating time, Loop time

Push [F] until display shows.

Loop

Push [P].

Display shows

L1 4

Alternating time for display time is 4 seconds.

Push [P] for desired alternating time (0-25). Accept with [F].

Display shows
seconds.

L2 0

Alternating time for display temperature is 0

Push [P] for desired alternating temperature (0-25). Accept with [F].

Display shows

L3 4

Alternating time for display date is 4 seconds.

Push [P] for desired alternating time (0-25). Accept with [F].

Push [R] for entering base mode or push [F] for next function.

Setting Correction value for the temperature sensors.

With this function the temperature sensors can be adjusted ± 9 °C.

Push [F] until display shows.

Corr

Push [P].

Display shows

C1 0

Push [P] for desired correction value (± 9 °C). Accept with [F].

Push [R] for entering base mode or push [F] for next function.

WESTERSTRAND URFABRIK AB

P.O. Box 133
SE-545 23 TÖREBODA

Tel. +46 506 48000
Fax. +46 506 48051

Internet: <http://www.westerstrand.se>
E-mail: info@westerstrand.se

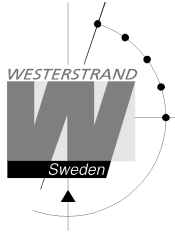

Setting DLS-function.

With this function the DLS can be activated.

Push [F] until display shows.

Push [P].

Display shows

or

Push [P] for DLS or not.

Push [R] for entering base mode or push [F] for next function.

Function as chronometer.

When used as chronometer the display is programmed from an external remote control unit.

Time can be counted up or down. At the end of the count period a buzzer signal is heard. The buzzer signal time is adjustable from 0-9 seconds. The buzzer can also be shut off manually.

There is an output for an external relay. The relay is a factory mounted option.

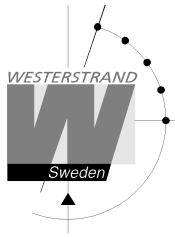

Programming of the chronometer standard control unit

Used as a chronometer the display of the clock is monitored from a remote control unit with seven buttons. [MODE], [S/S], [PRESET], [NO], [YES], [↑] och [↓].

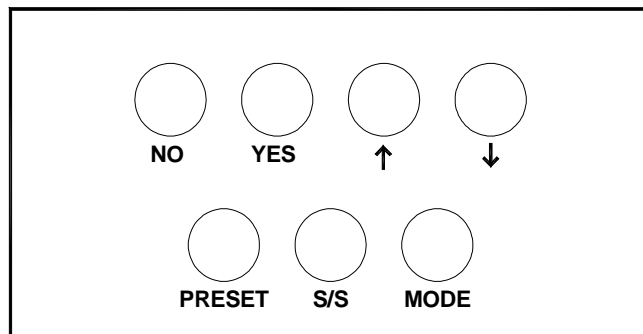

- [MODE] For the change between chronometer and clock.
- [S/S] Start/stop.
- [PRESET] Reset of time.
Reset can only be done when the clock is stopped.

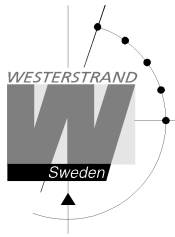

Programming can only be done in mode chronometer and time is stopped.

Press [NO].

If the unit is set to show hours "**HH:00**" is displayed.

If not programming starts with minutes, see below.

Press [↑] and [↓] until selected hour is shown. Accept with [YES].

Display shows "**nn:05**".

Press [↑] and [↓] until selected minute is shown. Accept with [YES].

Display shows "**SS:00**".

Press [↑] and [↓] until selected second is shown. Accept with [YES].

Display shows "**t :01**".

Set time for how long the buzzer will sound. (0-9 sec.)

If 0 sec. is chosen the buzzer is shut off by software.

Press [↑] and [↓] until wished buzzer time is shown. Accept with [YES].

Display shows "**UP** " or "**dn** ".

Select "UP" for count up, and "dn" for count down.

Press [NO] until selected text is shown. Press [YES].

Display shows "**dy** " or "**St** ".

Select "St" for static format display, and "dy" for dynamic format display.

Press [NO] until selected text is shown. Press [YES].

Display shows '**noAU**' or '**AUto**'. In setting 'AUto' the chronometer starts unconditionally when [MODE] is pressed from the clock mode.

Press [NO] until selected text is shown. Press [YES]

Display shows "**HnS** ", "**Hn** ", "**nSC** ", "**nS** ", "**nnS** " or "**nnC** ":

"Hns " Display shows hours, minutes and seconds.

"Hn " Display shows hours and minutes.

"nSC " Display shows minutes, seconds and 1/100s.

"nS " Display shows minutes (0-99) and seconds.

"nnS " Display shows minutes (0-9999) and seconds.

"nnC " Display shows minutes (0-9999) and 1/100 minutes.

Press [NO] until selected text is shown. Accept with [YES].

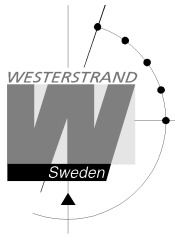

Programming of the chronometer option control unit

Used as a chronometer the display of the clock is monitored from a remote control unit with seven buttons. [MODE], [S/S], [PRESET], [H], [M], [S] and [↓].

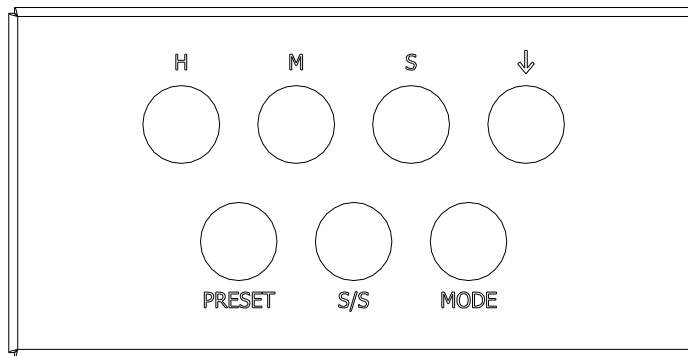

[H],[M],[S] Select chronometer start time: Hour, minute and second.

[S/S] Start/stop of chronometer time.

[PRESET] Sets the display to 00:00:00.

0:00:00

[↓] Choose count-down.

Example 1:

Choose count down from 5 minutes.

1. Make sure the chronometer is stopped by pressing [S/S].

2. Press [PRESET] to clear the display. The display shows:

0:00:00

3. Press [M] until the display shows:

0:05:00

4. Start by pressing [S/S]. After 5 minutes the buzzer sounds and the output for external relay is closed for 2 seconds.

5. To repeat the count down, press [↓] and then [S/S].

6. To program a new count-down time, press [PRESET] to clear the display, select the new time with [H] [M] [S]. When [S/S] is pressed, the new time is stored in the chronometer memory.

WESTERSTRAND URFABRIK AB

P.O. Box 133
SE-545 23 TÖREBODA

Tel. +46 506 48000
Fax. +46 506 48051

Internet: <http://www.westerstrand.se>
E-mail: info@westerstrand.se

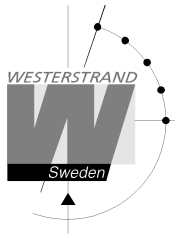

Example 2:

Choose count up from 0.

1. Make sure the chronometer is stopped by pressing [S/S].
2. Press [PRESET] to clear the display. The display shows:
3. Start by pressing [S/S]. The chronometer continues until it is stopped manually or 23:59:59 is reached.

0:00:00

Hidden functions:

Make sure that the clock is stopped

Press [PRESET] for 10 seconds.

Display shows "**HnS**", "**Hn**", "**nSC**", "**nS**", "**nnS**" or "**nnC**":

"Hns" Display shows hours, minutes and seconds.

"Hn" Display shows hours and minutes.

"nSC" Display shows minutes, seconds and 1/100s.

"nS" Display shows minutes (0-99) and seconds.

"nnS" Display shows minutes (0-9999) and seconds.

Press [S/S] until desired setting appears. Accept with [MODE].

Display shows '**noAU**' or '**AUto**'. In setting 'AUto' the chronometer restarts.

Press [S/S] until desired setting appears. Accept with [MODE].

Display shows "**UP**" or "**dn**".

Press [S/S] until desired setting appears. Accept with [MODE].

Display shows "**Ct**" or "**CC**".

"Ct" Display shows Chronometer or time.

"CC" Display shows only chronometer.

Press [S/S] until desired setting appears. Accept with [MODE].

Press [PRESET] for 10 seconds to exit the hidden function.

The clock is restarted.

WESTERSTRAND URFABRIK AB

P.O. Box 133
SE-545 23 TÖREBODA

Tel. +46 506 48000
Fax. +46 506 48051

Internet: <http://www.westerstrand.se>
E-mail: info@westerstrand.se

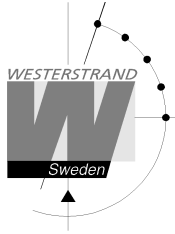

Technical specification

Mains	100-240VAC 50-60 Hz
Connection Current.	0.35A
Temperature range	0° - 40° C
Size of digits HH:MM:SS	50 mm/37mm, red, green, yellow SMD LED:s
Synchronisation	Polarised 24V impulse 1/1, TC, DCF
Accuracy	± 0.1 sec/24 hour
Running reserve	48 hour
Changing Summer/ Winter	Last Sunday in march, last Sunday in October.

WESTERSTRAND URFABRIK AB

P.O. Box 133
SE-545 23 TÖREBODA

Tel. +46 506 48000
Fax. +46 506 48051

Internet:: <http://www.westerstrand.se>
E-mail: info@westerstrand.se